

CATALOGUE 2011



General Information



Potentiometer Technical Information



Carbon & Wirewound Presets



Carbon Rotary Potentiometers - 16 mm size



Carbon Rotary Potentiometers - 20 mm size



Carbon Slider Potentiometers



Rotary Position Sensors



Switches



Membrane Keyboards





Alpha-numerical Index of Types

Index alpha-numérique des types

Used Technical Terms

Termes techniques utilisés



Potentiometers

CI DP20C	CI R1P160ZC	PG 24
CI DP 160KC	CI R11P160ZC	PG 24B
CI DP160ZC	CI R11P162C	
CI JP16C	CI R11P163C	
CI JP20C	CI R31P160ZC	
CI JP160C	CI R41P160ZC	
CI JP160KC		
CI JP160ZC	CI QDP160ZC	
CI JP162KC	CI TDP160ZC	PGP 40
CI JP162ZC	CI QJP160KC	PGP 58
	CI QJP160ZC	PGR40
CI PG 100M	CI TJP160KC	
CI PG 100S	CI TJP160ZC	
CI PG 101M		PGST 2.58M
CI PG 101S		PGST 2.58S
	DP 20C	PGST 2.58H
	DP160KC	
	DP 160ZC	PGST 40M
CI PGP 40		PGST 40S
CI PGP 58	EP 20	PGST 44
CI PGR 40	EP 20KC IL	PGST 44H
	EP 20KC 2IL	
CI PGST 2.58M		
CI PGST 2.58S	EP 160C IL	PM 10
	EP 160C 2IL	PM 18
CI PGST 40M	EP 160KC	PM 25
CI PGST 40 S	EPP 160KC	PM 40
CI PGST 44	EP 160KC IPP	
	EP 160Z	PR10 H
CI P20C	EPP 160Z	PR10 V
CI P20C IL	EP 160ZC	
CI P20C 2IFS	EPP160ZC	P15 H
CI P20C 2IL		P15 H SPDT
CI P20PD	EP 162	P15 V10
	EP 162KC	P15 V10 SPDT
CI P160C	EPP 162KC	
CI P160C IL	EP 162Z	P20C
CI P160C 2IL	EPP 162Z	P20C IL
CI P160KC	EP 165 IPP	P20C 2IFS
CI P160KC IP		P20C 2IL
CI P160KC IPDC	JP 16C	P20E
CI P160KC IPFC	JP 20C	P20EC
CI P160KC IPP	JP 160C	
CI P160TZC	JP 160KC	P20EC IL
	JP 160ZC	P20EC 2IL
CI P160ZC		P20E PD
CI P160ZC IP	JP 162KC	P20M
CI P161C	JP 162ZC	P20PD
CI P162C		
CIP162TZC		
CI P162KC	PB 3	
CI P162ZC	PB 3A	
CI P163C	PB 3AP	
	PB 3P	



P20S
P20S IL
P20S 2IL
P20SC
P20SC IL
P20SC 2IFS
P20SC 2IL

P21EC IL
P21EC 2IL

P160 BA
P160 BM

P160 IBA
P160 IBM
P160C
P160C IL
P160C 2IL
P160 EKC
P160 KC

P160 TZC
P160ZC
P160ZCS

P161EC IL
P161EC 2IL

P162 BA
P162 BM
P162C
P162EKC
P162KC
P162TZC
P162ZC
P162ZCS

QDP160ZC
QJP160KC
QJP160ZC

R11P162C

SP20

SP162
SP160Z
SP162Z

T10 FH
T10 FH SPDT
T10 H
T10 H SPDT
T10 FV
T10 FV SPDT
T10 V
T10 V SPDT

TR15 FH
TR15 FV10

TDP 160ZC
TJP 160ZC
TJP160 KC

Rotary position sensors

C15P
EP165
EP165 R31

P165 S
P165 SR31

Switches

CT 32D.2F.FT
CT 32D.2F.F10
CT 32D.2N.FT
CT 32D.2N.F10

CT 32D.4F.FT
CT 32D.4F.F10
CT 32D.4N.FT
CT 32D.4N.F10

CT 32D.6F.FT
CT 32D.6F.F10
CT 32D.6N.FT
CT 32D.6N.F10

CT 40D.2F.FT
CT 40D.2F.F10
CT 40D.2N.FT
CT 40D.2N.F10

CT 40D.4F.FT
CT 40D.4F.F10
CT 40D.4N.FT
CT 40D.4N.F10

CT 40D.6F.FT
CT40D.6F.F10
CT 40D.6N.FT
CT 40D.6N.F10

ST 1034
ST 1034D
ST 1034E
ST 1034F

ST 1042
ST 1044

Membrane keyboards

CC 20 12 00
CC 20 12 10
CC 20 16 00

CC 20 16 10
CM 20 12 00
CM 20 12 10

CM 20 16 00
CM 20 16 10



Used Technical Terms

Termes techniques utilisés

Suchwort - Verzeichnis

Termini tecnici usati

English	Français	Deutsch	Italiano
A			
Absolute linearity	Linéarité absolue	Absolute linearität	Linearità assoluta
AC voltage	Tension alternative	Wechselspannung	Tensione alternata
Anti-clockwise (CCW)	Sens anti-horaire	Entgegen dem Uhrzeigersinn	Senso antiorario
Applied voltage	Voltage appliqué	Betriebsspannung	Tensione applicata
Attenuation	Attenuation	Dämpfung	Attenuazione
B			
Bush	Canon	Buchse	Bussola
Bush length	Longueur du canon	Buchslänge	Lunghezza della bussola
C			
Carbon composition potentiometer	Potentiomètre à couche de carbone	Schichtstellwiderstand	Potenziometro a strato di carbone
Carbon composition preset	Ajustable à couche de carbone	Kohleschicht- Trimmerwiderstand	Trimmer a strato di carbone
Carbon track	Piste carbone	Kohleschicht	Pista di carbone
Central tap	Prise médiane	Mittelanzapfung	Presa centrale
Central click	Point milieu	Mittelrastung	Scatto centrale
Climatic conditions	Conditions climatiques	Klimabedingungen	Condizioni climatiche
Clockwise (CW)	Sens horaire	Im Uhrzeigersinn	Senso orario
Contact travel	Course du contact	Kontaktweg	Corsa del contatto
Curve	Courbe	Kurvenform	Tipo di curva
Curve tolerance	Tolérance de courbe	Kurventoleranz	Tolleranza della curva
D			
Decibel (db)	Décibel	Dezibel	Decibel
Derating curve	Courbe de dissipation	Belastungsdiagramm	Diagramma della potenza
Dual potentiometer	Potentiomètre double	Doppeldrehwiderstand	Potenziometro doppio comando separato
E			
Earth screen	Blindage de masse	Abschirmung	Schermatura di massa
Earth termination	Cosse de masse	Masselötstift	Terminale di massa
Edge control	Potentiomètre à molette	Knopf-widerstand	Potenziometro comando a manopola



Used Technical Terms

Termes techniques utilisés Suchwort - Verzeichnis Termini tecnici usati

English	Français	Deutsch	Italiano
Electrical specification	Spécification électrique	Elektrischer Daten	Specifica elettrica
End stop value	Résistance résiduelle de fin de course	Endanschlagwert	Resistenza residua di fine corsa
End stop torque	Couple en butée	Anschlagfestigkeit	Coppia di arresto
G			
Graphite tipped wiper	Contact carbone	Kohlekontakt	Contatto di carbone
Ganged potentiometer	Potentiomètre jumelé	Tandemdrehwiderstand	Potenzimetro doppio comando unico
H			
Hop-off resistance (RE)	Saut de la résistance en fin de course	Endspringwert	Salto della resistenza a fine corsa
Hop-on resistance (RA)	Saut de la résistance au démarrage	Anfangsspringwert	Salto della resistenza a inizio corsa
Horizontal mounting	Fixation horizontale	Waagerechte Montage	Montaggio orizzontale
I			
Initial stop value	Résistance résiduelle de début de course	Anfangsansschlagwert	Resistenza residua di inizio corsa
Insulation resistance	Résistance d'isolement	Isolationswiderstand	Resistenza d'isolamento
K			
Knob	Bouton	Knopf	Manopola
Knurled spindle	Axe cannelé	Gerändelte Welle	Albero rigato
L			
Law (curve)	Courbe	Kurvenform	Tipo di curva
Linearity	Linéarité	Linearität	Linearità
Locating key	Ergot de positionnement	Drehsicherung	Dentino di posizionamento
Lockwasher, toothed	Rondelle éventail	Sicherungsscheibe	Rondella dentellata
M			
Mains switch	Interrupteur secteur	Netzschalter	Interruttore di rete
Matching (synchronism)	Appariage	Gleichlauf	Accoppiamento
Maximum attenuation	Atténuation maximale	Maximale Dämpfung	Attenuazione massima
Maximum voltage	Tension maximale	Grenzspannung	Tensione massima
Mechanical rotation	Rotation mécanique	Mechanischer Drehwinkel	Rotazione meccanica
Mechanical specification	Spécification mécanique	Mechanischer Spezifikation	Specifica meccanica
Mechanical travel	Course mécanique	Mechanischer Schiebeweg	Corsa meccanica
Moulded spindle	Axe moulé	Kunststoffwelle	Albero stampato
Moving contact	Contact du curseur	Schleiferkontakt	Contatto mobile



Used Technical Terms

Termes techniques utilisés

Suchwort - Verzeichnis

Termini tecnici usati

English	Français	Deutsch	Italiano
N			
Noise	Bruit de fond	Widerstandsrauschen	Rumore di fondo
Nut	Ecrou	Mutter	Dado
O			
Operating force	Force de glissement	Schiebekraft	Forza di spostamento
Operating spindle	Axe de commande	Betätigungswelle	Albero di comando
Operating torque	Couple de rotation	Drehmoment	Coppia di rotazione
Operating voltage	Tension de service	Betriebsspannung	Tensione di lavoro
P			
Potentiometer	Potentiomètre	Stellwiderstand	Potenziometro
Preset potentiometer	Potentiomètre ajustable	Trimmerwiderstand	Trimmer
Printed circuit (P.c.)	Circuit imprimé	Gedruckte Schaltung	Circuito stampato
Printed circuit mounting	Fixation pour circuit imprimé	Gedruckte Schaltung Montage	Montaggio per circuito stampato
R			
Rated current	Courant nominal	Nennstrom	Corrente nominale
Rated dissipation	Dissipation nominale	Nennbelastung	Dissipazione nominale
Rated resistance	Résistance nominale	Nennwiderstand	Resistenza nominale
Rated voltage	Tension nominale	Nennspannung	Tensione nominale
Resistance law	Courbe de résistance	Widerstandskurve	Curva della resistenza
Resistance range	Gamme de résistance	Widerstandsbereich	Gamma delle resistenze
Resistance tolerance	Tolérance de résistance	Widerstandstoleranz	Tolleranza della resistenza
Resistance track	Piste résistance	Widerstandsschicht	Pista resistiva
Resistance value	Valeur de résistance	Widerstandswert	Valore di resistenza
Rotary potentiometer	Potentiomètre rotatif	Drehwiderstand	Potenziometro rotativo
Rotary switch	Interrupteur rotatif	Drehschalter	Interruttore rotativo
Rotation angle	Angle de rotation	Drehwinkel	Angolo di rotazione
S			
Screwdriver slot	Fente tournevis	Schraubendreher-Schlit	Taglio per cacciavite
Slider potentiometer	Potentiomètre glissière	Schiebewiderstand	Potenziometro slider
Solder lug (solder tag)	Cosse à souder	Lötöse	Terminale a saldare
Spindle	Axe	Welle	Albero di comando
Spindle length	Longueur d'axe	Wellenlänge	Lunghezza albero di comando



Used Technical Terms

Termes techniques utilisés

Suchwort - Verzeichnis

Termini tecnici usati

English	Français	Deutsch	Italiano
Spindle variations	Types d'axe	Ausführungen der Welle	Tipo di albero
Standard bush	Canon standard	Standard Buchse	Bussola standard
Standard resistance	Résistance standard	Standardwiderstand	Resistenza standard
Switch	Interrupteur	Schalter	Interruttore
Switching angle	Angle de fonctionnement de l'interrupteur	Schaltwinkel	Angolo di lavoro dell'interruttore
T			
Tap resistance (value)	Résistance de la prise	Anzapf Widerstand	Resistenza della presa
Tap	Prise	Anzapfung	Presa
Temperature coefficient	Coefficient de température	Temperaturkoeffizient	Coefficiente di temperatura
Temperature range	Gamme de température	Temperaturbereich	Gamma di temperatura
Terminations	Cosses	Lötflächen	Terminali
Test voltage	Tension d'essai	Prüfspannung	Tensione di prova
Thread	Filetage	Gewinde	Filettatura
Tolerance	Tolérance	Toleranz	Tolleranza
Total resistance	Résistance totale	Gesamtwiderstand	Resistenza totale
Travel	Course	Schiebeweg	Corsa
Twist tab	Patte déformable	Schränklappen	Aletta a torcere
V			
Value	Valeur	Widerstandswert	Valore
Varicap diode application	Application pour diode varicap	Kapazitätsdioden-Anwendung	Applicazione diodo varicap
Vertical mounting	Montage vertical	Senkrecht Montage	Montaggio verticale
Voltage rating	Tension nominale	Nennspannung	Tensione nominale
W			
Wirewound preset	Potentiomètre ajustable bobiné	Drahttrimmerwiderstand	Trimmer a filo
Working voltage	Tension de service	Betriebsspannung	Tensione di lavoro



Reference Specifications	<i>Spécifications de référence</i>
List of used Symbols	<i>Liste des symboles utilisés</i>
Glossary of Terms	<i>Glossaire des termes</i>
Standard Resistance Values	<i>Valeurs normalisées de résistance</i>
Marking Code	<i>Code de marquage</i>
Category & Tests	<i>Catégorie et essais</i>
Power Dissipation & Working Voltage Curves	<i>Courbes de dissipation et tension de service</i>
Linearity Tolerance	<i>Tolérance de linéarité</i>
Derating Curve	<i>Courbe de réduction de dissipation</i>
Matching Tolerance for Ganged Stereo Potentiometers	<i>Appariage pour les potentiomètres jumelés stéréo</i>
Resistance Laws	<i>Lois de variation de la résistance</i>
Application Notes	<i>Notes sur l'utilisation</i>



IEC 190	Non-wirewound potentiometers Type 2
IEC 393-1	Potentiometers - Part. 1: Terms and methods of test
CECC 41000	Generic Specifications: Potentiometers
CECC 41100	Lead-screw actuated and rotary preset potentiometers - Sectional specification
CECC 41101	Lead-screw actuated and rotary preset potentiometers - Blank Detail Specification
<i>IEC 190</i>	<i>Potentiomètres non bobinés Type 2</i>
<i>IEC 393-1</i>	<i>Potentiomètres - Première partie: Définitions et méthodes d'essai</i>
<i>CECC 41000</i>	<i>Spécification générique: Potentiomètres</i>
<i>CECC 41100</i>	<i>Potentiomètres de réglage à commande par vis et rotatifs - Spécification intermédiaire</i>
<i>CECC 41101</i>	<i>Potentiomètres de réglage commandés par vis - Spécification particulière cadre.</i>



Liste of used Symbols

Liste des symboles utilisés

A	=	Initial termination	<i>Cosse début de course</i>
AA	=	Initial attenuation	<i>Atténuation de démarrage</i>
A W	=	Initial path	<i>Plage de démarrage</i>
C	=	Travel of slider potentiometers	<i>Course des potentiomètres à glissière</i>
C E	=	Effective electrical travel of slider potentiometers	<i>Course électrique utile des potentiomètres à glissière</i>
C N	=	Total mechanical travel of slider potentiometers	<i>Course mécanique totale des potentiomètres à glissière</i>
C Z	=	Mechanical position of tap in slider potentiometer	<i>Position mécanique de la prise des potentiomètres à glissière</i>
DPST	=	Double-pole, single throw	<i>Interrupteur bipolaire</i>
E	=	End termination	<i>Cosse fin de course</i>
EA	=	Final attenuation	<i>Atténuation d'arrivée</i>
E W	=	Final path	<i>Plage d'arrivée</i>
R a	=	Initial stop value	<i>Résistance résiduelle de début de course</i>
R A	=	Hop-on resistance	<i>Saut de la résistance de démarrage</i>
R e	=	End stop value	<i>Résistance résiduelle de fin de course</i>
R E	=	Hop-off resistance	<i>Saut de la résistance de fin de course</i>
R N	=	Rated resistance	<i>Résistance nominale</i>
R T	=	Effective resistance	<i>Résistance effective</i>
R Z	=	Rated value of the tap	<i>Résistance nominale de la prise</i>
ϕ	=	Rotation angle of rotary potentiometers	<i>Angle de rotation des potentiomètres rotatifs</i>
ϕ E	=	Effective electrical rotation angle of rotary potentiometer	<i>Angle de rotation électrique utile des potentiomètres rotatifs</i>
ϕ N	=	Total mechanical rotation angle of rotary potentiometers	<i>Angle de rotation mécanique total des potentiomètres rotatifs</i>
ϕ Z	=	Mechanical position of tap in rotary potentiometers	<i>Position mécanique de la prise des potentiomètres rotatifs</i>
S	=	Moving contact termination	<i>Sortie du contact mobile (courseurs)</i>
SPDT	=	Single-pole, double throw	<i>Commutateur unipolaire</i>
SPST	=	Single-pole, single throw	<i>Interrupteur unipolaire</i>
Z	=	Tap	<i>Prise</i>

Angle of rotation of rotary potentiometers

The total mechanical rotation and the effective electrical rotation for potentiometers with switch and without switch are shown below.

Angle de rotation pour les potentiomètres rotatifs

Les angles de rotation mécanique total et électrique utile pour les potentiomètres avec ou sans interrupteur sont indiqués ci-dessous.

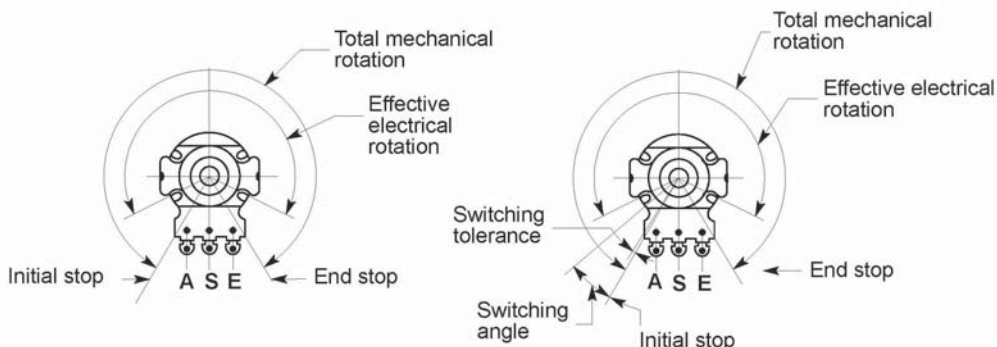

Viewed on spindle side

Vue côté de l'axe

Potentiometers without switch or with push-push switch.

Clockwise rotation

Rotation en sens horaire

Potentiometers with rotary switch.

Travel and terminations of slider potentiometers

Course et sorties des potentiomètres à glissière

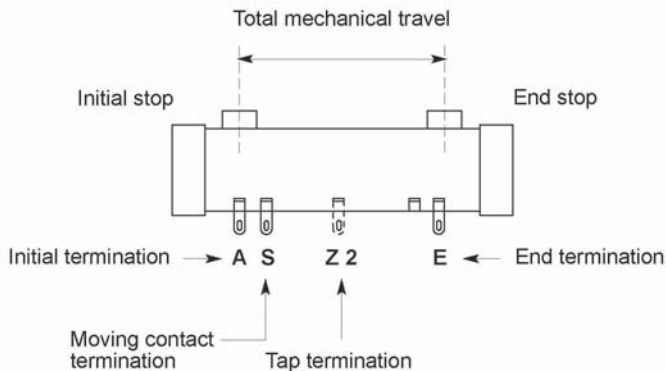



End stop value

Resistance value between the end terminations E and the moving contact termination S when the moving contact is set to the end stop position.

Résistance résiduelle de fin de course

Valeur de la résistance entre les cosses E et S du curseur lorsque le contact mobile est en fin de course.

Initial stop value

Resistance value between the initial termination A and the moving contact termination S when the moving contact is set in initial stop position..

Résistance résiduelle de début de course

Valeur de la résistance entre les cosses A et S du curseur lorsque le contact mobile est en début de course.

Insulation resistance

Resistance measured between interconnected terminations and all other external metal parts.

Résistance d'isolement

La résistance d'isolement est mesurée entre toutes les cosses du potentiomètre reliées entre-elles et toutes les autres parties métalliques.

Limiting element voltage

At low values of resistance the maximum voltage that may be applied to a potentiometer is calculated from the rated dissipation and the resistance value. At high values of resistance the voltage calculated in this way may not be applicable to a potentiometer because the maximum voltage that may be applied to a potentiometer is dependent on its size and construction. The maximum voltage is described as the limiting element voltage.

Tension limite de l'élément

Pour les potentiomètres de faible valeur, la tension maximale qui peut être appliquée à la résistance est calculée à partir de la dissipation nominale et de la valeur de la résistance.

Pour les potentiomètres de forte valeur, la tension calculée de cette manière ne peut être appliquée à la résistance car la tension maximale, pouvant être appliquée à une résistance, dépend des dimensions et de la construction de la résistance. Cette tension maximale est appelée tension limite de l'élément.

Matching tolerance of the resistance law

Maximum difference, expressed in dB, between the attenuations introduced by each resistor unit of stereo potentiometers.

Tolérance d'appariage de la loi de variation

Différence maximale, exprimée en décibels, entre les atténuations introduites par chaque élément de résistance du potentiomètre stéréo.



Maximum voltage

Maximum voltage V max that may be applied is calculated from maximum dissipation P and nominal resistance R_N : $V \text{ max} = \sqrt{P \cdot R_N}$, provided that the limiting element voltage is not exceeded.

Tension maximale

La tension maximale $V \text{ max}$ qui peut être appliquée est calculée à partir de la dissipation nominale P et de la valeur nominale de la résistance R_N : $V \text{ max} = \sqrt{P \cdot R_N}$; cette tension maximale ne peut excéder la tension limite.

Paths

Initial path: the path travelled by the moving contact to reach the effective electrical rotation range ϕ E for rotary potentiometers or the effective electrical travel CE for slider potentiometers, from A.

Final path: the path travelled by the moving contact to reach E after leaving the effective electrical rotation range ϕ E for rotary potentiometers or the effective electrical travel CE for slider potentiometers.

Plage de démarrage

Parcours du contact mobile pour accéder à la zone ϕ E de la rotation électrique utile pour les potentiomètres rotatifs, ou à la zone CE de la course électrique utile pour les potentiomètres à glissière, à partir de la butée A.

Plage d'arrivée

Parcours du contact mobile pour accéder à la butée E après avoir balayé la zone ϕ E des potentiomètres rotatifs ou la zone CE des potentiomètres à glissière.

Rated dissipation

Maximum allowable dissipation at a given ambient temperature, when the potentiometer is continuously loaded between the initial termination A and the end termination E and mounted on a 100 x 100 x 1,5 mm steel panel, subject to the limiting voltage not being exceeded.

Dissipation nominale

C'est la dissipation maximale admissible, à une température ambiante donnée, lorsque le potentiomètre est fixé normalement sur une plaque d'acier ayant les dimensions de 100 x 100 x 1,5 mm, et qu'une tension est appliquée en permanence entre les cosses A et E, à condition que cette tension ne soit pas supérieure à la tension limite de l'élément.

Rated resistance

Nominal value of the resistance between the beginning termination A and the end termination E when the spindle is fully at the beginning or end of travel position.

Résistance nominale

Valeur nominale de la résistance entre la cosse initiale A et la cosse finale E, lorsque le contact mobile est placé en butée de début ou de fin de course.



Rated value of the tap

Nominal value of resistance between the beginning termination A and the tap termination Z.

Résistance nominale de la prise

Valeur nominale de la résistance entre la cosse initiale A et la cosse de la prise Z.

Resistance law

Relation between the displacement of the moving contact and the resistance between the beginning termination A and the moving contact termination S.

Loi de variation de la résistance

Relation entre le déplacement du contact mobile et la résistance à partir de la cosse initiale A.

Switch

Mains-voltage or battery-voltage switch, fitted to the potentiometer and controlled by the potentiometer spindle.

Interrupteur

Interrupteur de tension, monté sur le potentiomètre et commandé par l'axe du potentiomètre.

Switching angle

Angle over which the switch has to be actuated from the off to the on-position, or vice-versa.

Angle de fonctionnement de l'interrupteur

Angle de rotation mécanique entre la butée initiale et le point de repos où l'interrupteur a établi le circuit, et vice-versa.

Tap contact resistance

The lowest adjustable resistance between the tap termination Z and the moving contact termination S.

Résistance de contact de la prise

La plus faible valeur de résistance entre la cosse de la prise Z et la cosse du contact mobile S.

Total resistance

Resistance actually measured between the initial termination A and the end termination E when the spindle is in fully beginning or end travel position. It differs from the rated resistance by the inclusion of admissible tolerances.

Résistance totale

C'est la valeur mesurée de la résistance entre les cosses A et E, lorsque le curseur est en butée de début ou de fin de course. Cette valeur peut être différente de la résistance nominale en fonction de la tolérance admissible.



Standard resistance values

In the table below are the recommended standard values of rated resistance, according to IEC Publ. 63.

Dans le tableau suivant sont indiquées les valeurs recommandées de la résistance nominale, en accord avec la Publication CEI 63.

Series E3

100 R	220 R	470 R	1K0	2K2	4K7	10 K	22 K	47 K	100K	220K	470K	1M0	2M2	4M7
-------	-------	-------	-----	-----	-----	------	------	------	------	------	------	-----	-----	-----

Series E6

100R	150R	220R	330R	470R	680R	1K0	1K5	2K2	3K3	4K7	6K8	10K	15K	22K	33K
47K	68K	100K	150K	220K	330K	470K	680K	1M0	1M5	2M2	3M3	4M7			

Obtainable values are specified on the pages describing each potentiometer type.

Voir en feuille particulière les valeurs minimales et maximales fabriquées pour chaque type.

Marking Codes

Resistance values are marked on the potentiometers according to the coding of IEC Publ. 62.

The code consist of three or four characters.

Three characters (two figures and a letter) are used if the value has 2 significant figures.

Four characters (three figures and a letter) are used if the value has 3 significant figures.

The letters R, K, M are used as multiples, representing 1, 10^3 and 10^6 respectively, operating on the resistance values in ohm.

The letters take the place of any decimal point: $220\Omega = 220R$; $1\text{ K}\Omega = 1K0$; $4,7\text{ K}\Omega = 4K7$.

Les valeurs de résistance sont marquées sur les potentiomètres, en accord avec la Publication CEI 62. Le code consiste en trois ou quatre caractères.

Trois caractères (deux chiffres et une lettre) sont employés lorsque la valeur est composée de deux chiffres significatifs.

Quatre caractères (trois chiffres et une lettre) sont employés lorsque la valeur est composée de trois chiffres significatifs.

Les lettres R, K, M sont employées comme multiplicateurs, et elles représentent: 1, 10^3 et 10^6 respectivement, lorsque la résistance est exprimée en ohm.

Les lettres sont mises à la place du point décimal: $220\Omega = 220R$; $1\text{ K}\Omega = 1K0$; $4,7\text{ K}\Omega = 4K7$.



The Radiohm potentiometers belong to **25/070/21 Category - Publ. IEC 190** and are tested according to the Publ. IEC 393-1; they meet also the specifications of the following tests **DIN 41 450**.

Test	DIN 41 450				IEC 393-1		
	Radiohm typical results $\Delta R\%$		DIN values $\Delta R\%$		Publ.	Proc.	Degree of severity
Temperature coefficient							
Preset	100 Ω to 470 K ± 300 ppm/ $^{\circ}$ C		100 Ω to 22 K ± 1000 ppm/ $^{\circ}$ C				
Potentiometers	100 Ω to 22 K ± 1000 ppm/ $^{\circ}$ C > 22 K to 4.7 M +300/-1000 ppm/ $^{\circ}$ C		> 22 K to 4.7 M +300/-1000 ppm/ $^{\circ}$ C				
Short time climatic test (Dry heat)	5%		5%		68-2-2	Ba	16 h +70 $^{\circ}$ C
Long time climatic test (Damp heat)	5%		15%		68-2-3	C	H = 93% T = 40 $^{\circ}$ C 21 days
Life test Potent. = 10.000 cycles Presets = 500 cycles	≤ 100 K	3%	≤ 100 K	5%	393-1	6.28.1	5-10
	> 100 K	5%	> 100 K	10%			
Load test (nominal load)	≤ 500 K	5%	≤ 500 K	10%			
	> 500 K	10%	> 500 K	15%			
Solderability	Good spreading of the solder terminals. (95% of treated surface)				68.2.20	T	
Heat resistance	$\pm 1\%$		$\pm 2\%$				
Cold					68.2.1	Aa	16 H -10 $^{\circ}$ C or -25 $^{\circ}$ C
Resistance to cleaning fluids and solvents (1)	10%		10%				
Permanent storage	5%		5%				
Robustness of terminations					68.2.21	Ub	

(1) Carbon presets only.



Explanation to measurements and tests to DIN 41 450

Temperature coefficient

24 hours drying at $55^{\circ}\text{C} \pm 2^{\circ}\text{C}$ and $20\% \pm 2\%$ relative humidity.
Measurement of RT at -25°C , at $+23^{\circ}\text{C}$, at $+85^{\circ}\text{C}$.
During the measurement the relative humidity is $\leq 50\%$.

Short time climatic test

24 hours storage at $23^{\circ}\text{C} \pm 1^{\circ}\text{C}$ and $50\% \pm 2\%$ relative humidity.
Measurement of RT at the same climate.
16 hours storage at 85°C .
2 hours storage in a preparatory climate.
2 hours storage at $-25^{\circ}\text{C} \pm 2^{\circ}\text{C}$.
16 hours storage in a preparatory climate.
Final measurement RT in the preparatory climat.

Long time climatic test

24 hours storage at $23^{\circ}\text{C} \pm 1^{\circ}\text{C}$ and $50\% \pm 2\%$ relative humidity.
Measurement of RT at the same climate.
21 days storage at $23^{\circ}\text{C} \pm 2^{\circ}\text{C}$ and $83\% \pm 3\%$ relative humidity.
24 hours storage in a preparatory climate.
Final measurement RT in the preparatory climat.

Life test

At a speed of 10 to 15 double movements per minute the spindle is moved 10.000 times - trimmers 500 times - to and from over the entire tuning range. This test is carried out at an ambient temperature of $23^{\circ}\text{C} \pm 10^{\circ}\text{C}$ and 40% to 70% relative humidity.

Load test

The load test is carried out at the nominal load with regard to the critical voltage. The initial measurement is made after 24 hours' storage in a preparatory climate at $23^{\circ}\text{C} \pm 1^{\circ}\text{C}$ and $50\% \pm 2\%$ relative humidity. The samples are mounted individually on metal plates of $50 \times 50 \times 1.5$ mm which are placed in a test chamber in such a way that the spindle of the potentiometers are in a horizontal position and that the potentiometers do not influence each other by their own heat. The load is applied during 84 days at an ambient temperature of $40^{\circ}\text{C} \pm 2^{\circ}\text{C}$, the load being alternatively switched on for $1\frac{1}{2}$ hours and switched off for $\frac{1}{2}$ hour. After the load test follows a 24 hours after-treatment at $20^{\circ}\text{C} \pm 2^{\circ}\text{C}$ and $75\% \pm 2\%$ relative humidity. Afterwards the measurement of the overall resistance RT is registered.
Presets are soldered onto printed circuit boards $50 \times 50 \times 1.5$ mm before the load test is carried out.



Solderability

Bath in flux (25% colophony) for 5 sec then immerse terminations in a Sn/Pb (60/40) bath at 235°C for 5 sec.

Heat resistance

24 hours storage at $55^{\circ}\text{C} \pm 2^{\circ}\text{C}$ and $\leq 20\%$ relative humidity.

Measurement of RT at the same climate.

Immersion of the terminations in a Sn/Pb (60/40) bath at 350°C to within 3 mm of the body for 2 sec (potentiometer mounted on a p.c.b. of 1.5 mm thickness).

Measurement of RT after 24 hours at normal ambient ($23^{\circ}\text{C} \pm 2^{\circ}\text{C}$ and 45% to 70% relative humidity).

Resistance to cleaning fluids and solvents

24 hours storage at $23^{\circ}\text{C} \pm 2^{\circ}\text{C}$ and $50\% \pm 2\%$ relative humidity.

Immersion for 10 minutes in each of the following fluids: alcohol isopropyllic, alcohol trichloroethane, trichloroethylene, xylene, freon TF, TMC.

Measurement of RT after 24 hours at normal ambient ($23^{\circ}\text{C} \pm 2^{\circ}\text{C}$ and 45% to 70% relative humidity).

Permanent storage

24 hours' storage at $23^{\circ}\text{C} \pm 1^{\circ}\text{C}$ and $50\% \pm 2\%$ relative humidity.

Measurement of RT at a preparatory climate.

6 months' storage at room temperature; the relative humidity may vary between 50% and 70%.

Measurement of RT in a preparatory climate.



0.1 W Rated dissipation

Power dissipation curve

Max working voltage curve

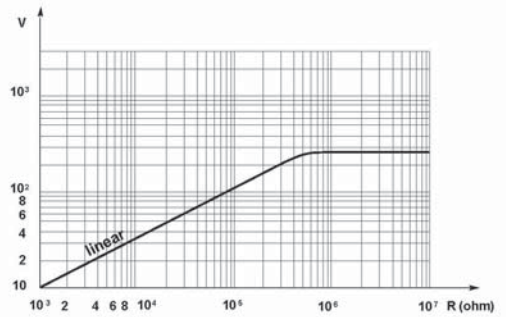
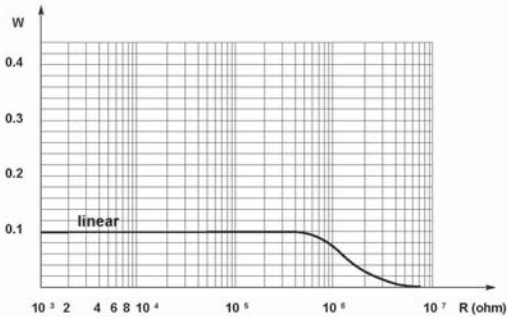

0.2 W Rated dissipation

Power dissipation curve

Max working voltage curve

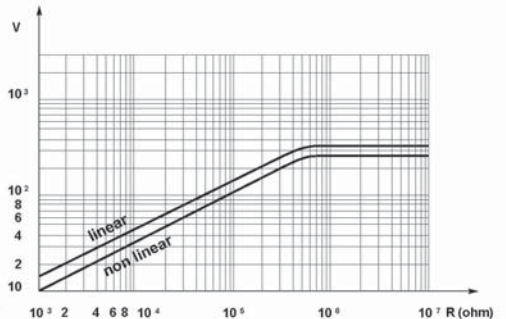
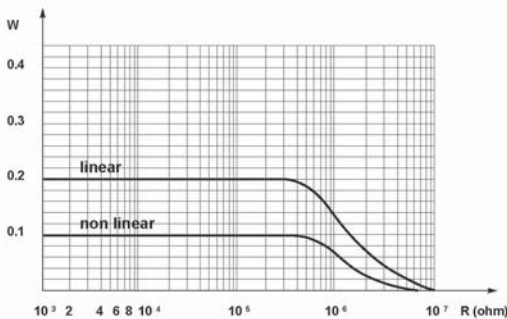



0.25 W Rated dissipation

Power dissipation curve

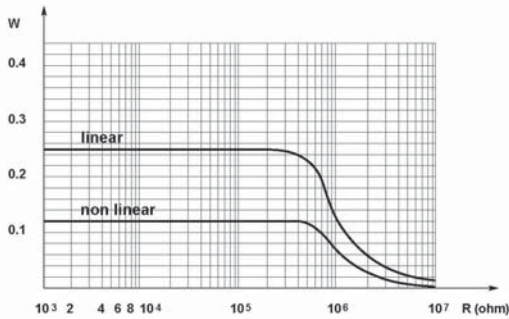

Max working voltage curve

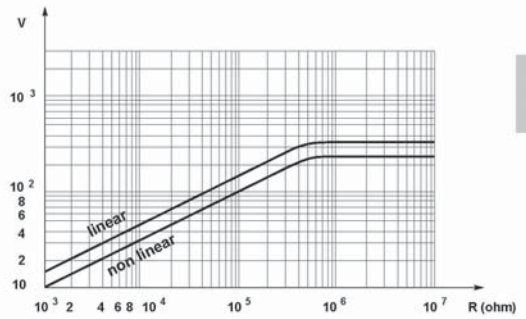

0.4 W Rated dissipation

Power dissipation curve

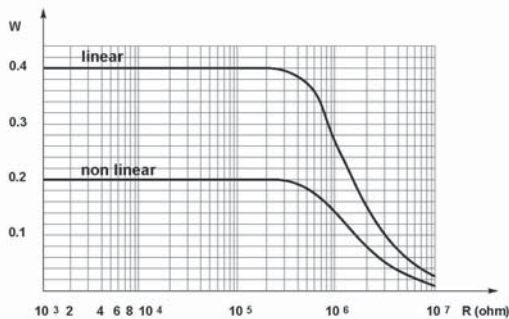

Max working voltage curve

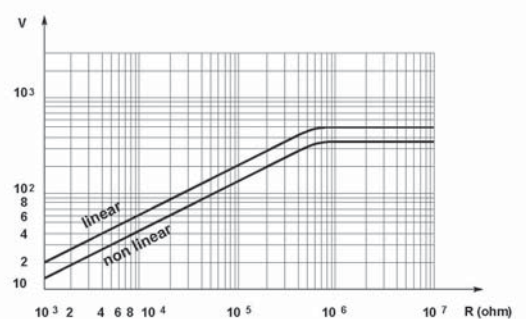



0.5 W Rated dissipation

Power dissipation curve

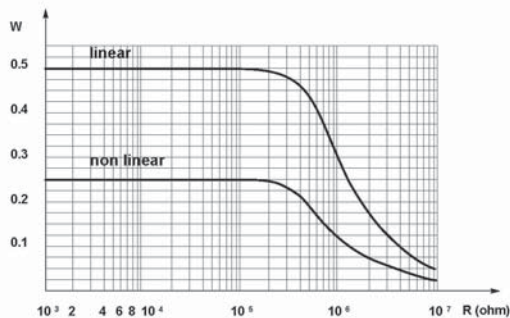

Max working voltage curve

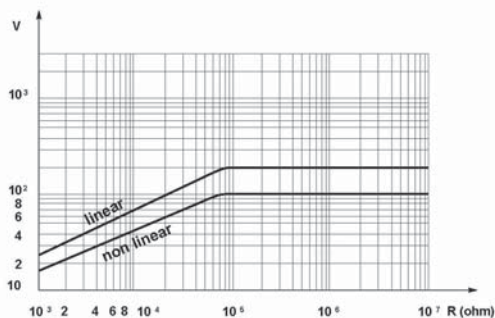



Linearity tolerance (Independent linearity)

The maximum vertical deviation, expressed as a percentage of the total applied voltage, of the actual law from a straight reference line with its slope and position chosen to minimize deviation over at least 70% of the effective electrical travel.

Ecart maximal en pourcentage de la tension totale appliquée, entre la loi de variation réalisée et une droite de référence dont la pente et la position sont choisies de manière à minimiser les écarts sur une portion correspondante au moins à 70% de la course électrique utile (linéarité pondérée).

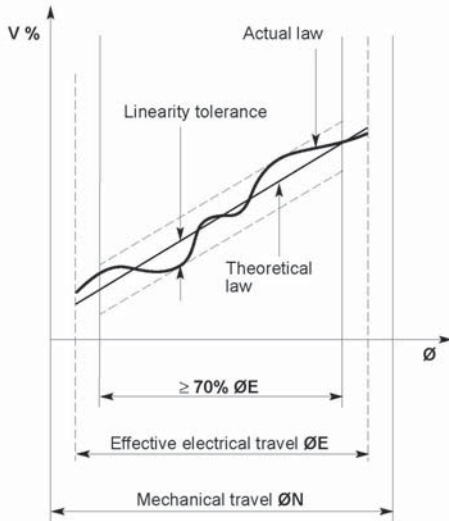

Carbon preset & Rotary types	Linearity tolerance
Rated resistance 1K0 to 1M0:	≤ 4%
over 1M0 to 4M7:	≤ 6%
Carbon slider types	
Rated resistance 1K0 to 4M7:	≤ 6%

Derating Curve

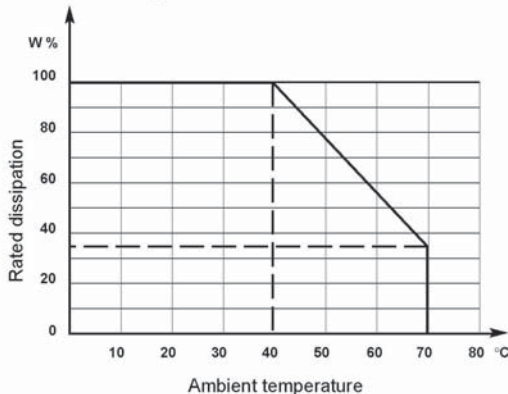

At ambient temperature lower than 40°C the rated power may be applied; at ambient temperature higher than 40°C the applied power shall be derated according to the curve.

For high resistance values the limiting element voltage could be the limiting factor instead of power dissipation.

When only A and S, or E and S terminations are connected, and the moving contact is set at less than 100% of the effective electrical travel, the limiting moving contact current may define the limiting dissipation.



Matching Tolerance for Ganged Stereo Potentiometers

Appariage pour les potentiomètres jumelés stéréo

Ganged potentiometers in this series have two identical resistor units with the same variation law. The mismatching of the two resistor units expressed in dB, is measured by the difference between the attenuations introduced by each resistor unit, at various points of the rotation.

Tolerance values for any resistance law are listed in the following table.

Obtainable laws and classes are specified on the pages describing each potentiometer type.

Les potentiomètres jumelés de cette série ont les deux courbes de variation de la résistance appariées. La tolérance d'appariage entre les deux courbes exprimée en dB, est mesurée par la différence des atténuations produites par l'une et l'autre résistance, aux différents points de la course du contact mobile.

Les valeurs des tolérances pour les différentes courbes sont indiquées dans le tableau suivant.

Les possibilités pour chaque type de potentiomètre sont indiquées en page particulière.

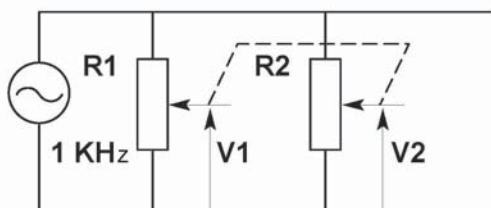

Law	Attenuation	Matching Tolerance = $20 \log \frac{V_1}{V_2}$	
		Class I	Class II
A } A2 }	0 – 20 dB > 20 dB	2 dB Not specified	3 dB Not specified
S } S2 }	0 – 20 dB 20 – 30 dB > 30 dB	2 dB 4 dB Not specified	3 dB Not specified Not specified
B } B2 } C } C2 } T }	0 – 20 dB 20 – 30 dB 30 – 40 dB 40 – 46 dB > 46 dB	2 dB 3 dB 3 dB 4 dB Not specified	2 dB 3 dB 4 dB Not specified Not specified
F } X }	0 – 20 dB 20 – 30 dB 30 – 40 dB 40 – 46 dB > 46 dB	2 dB 3 dB 4 dB 6 dB Not specified	2 dB 3 dB 4 dB Not specified Not specified

Attenuations and matching tolerances are measured in clockwise rotation (from A to E termination), but the reversed logarithmic laws (C - C2 - X) are measured in anti-clockwise rotation (from E to A termination).



Resistance Law

Loi de variation de la résistance

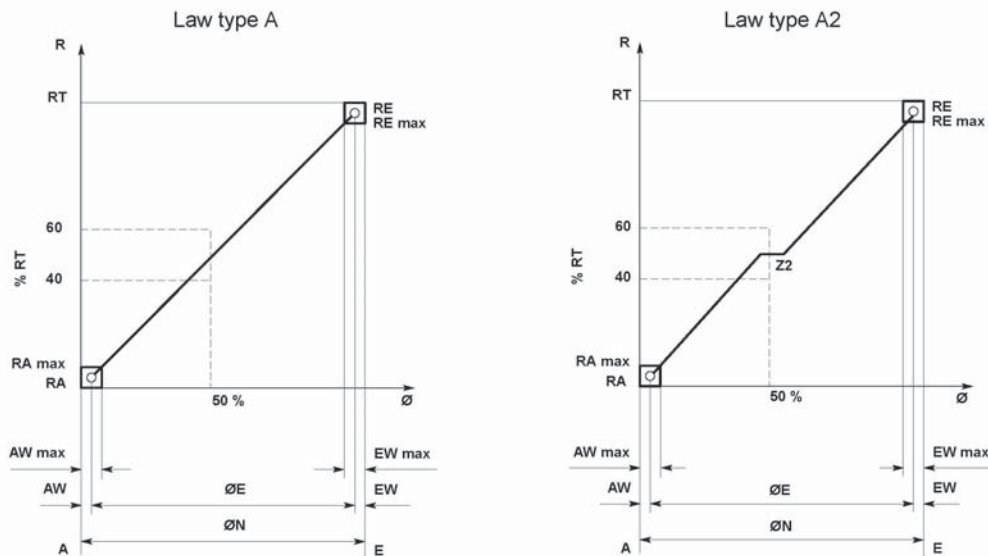

Rotary types: clockwise rotation.

Slider types: travel from A towards E termination.

Law	Ra	Re	RA	RE	AW max	EW max
Carbon preset types						
A	$\leq 2 \cdot 10^{-3} RN$ (*)	$\leq 2 \cdot 10^{-3} RN$ (*)	$\leq 5 \cdot 10^{-2} RN$	$\leq 5 \cdot 10^{-2} RN$	15% $\varnothing N$	
Other types						
A	$\leq 1 \cdot 10^{-3} RN$ (*)	$\leq 1 \cdot 10^{-3} RN$ (*)	$\leq 2 \cdot 10^{-2} RN$	$\leq 2 \cdot 10^{-2} RN$	7% $\varnothing N$ (1)	
A2						

(*) Minimum value: 2Ω

(1) 20 mm Rotary types: AW max = 12% $\varnothing N$; EW max = 10% $\varnothing N$

Law	Tap	$\varnothing Z$	RZ (nom.)	Contact resistance
A2	Z2	$50\% \varnothing N \pm 5\%$	50% RT	$\leq 1 \cdot 10^{-2} RZ2^*$
		20 mm Rotary with switch types = $52\% \varnothing N \pm 5\%$		

* Minimum value: 10Ω

Obtainable resistance laws are specified on the pages describing each potentiometer type.



Resistance Law

Loi de variation de la résistance

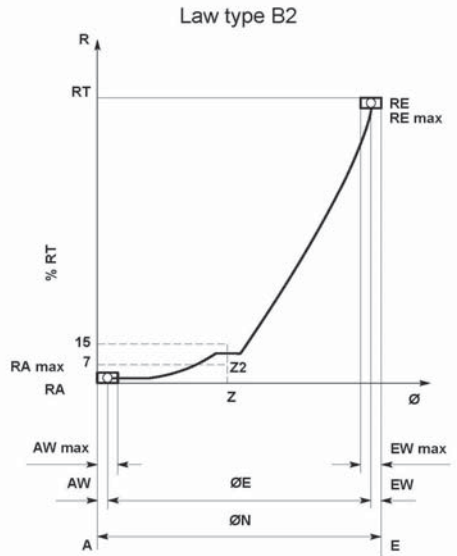
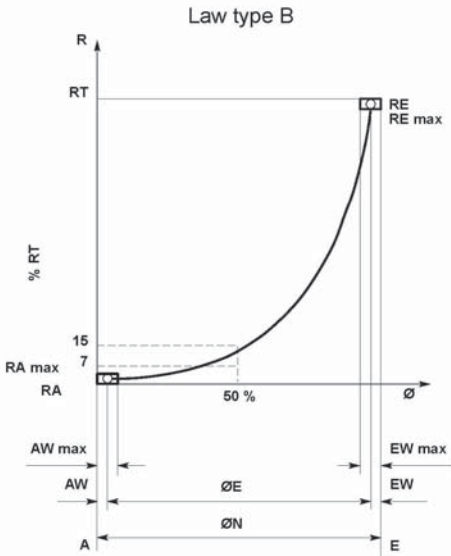

Rotary types: clockwise rotation.

Slider types: travel from A towards E termination.

Law	Ra	Re	RA	RE	AW max	EW max
B	$RN \leq 10K \leq 1.10^{-3} RN^*$	$RN \leq 100K \leq 2.10^{-2} RN$	$RN < 10K \leq 5.10^{-3} RN^*$	$\leq 5.10^{-2} RN$	7% Ø N (1)	
B2	$RN > 10K \leq 2.10^{-4} RN^*$	$RN > 100K \leq 1.10^{-2} RN$	$RN \geq 10K \leq 1.10^{-3} RN^*$			

* Minimum values: $RN \leq 10K = 2\Omega$; $RN > 10K = 10\Omega$

(1) 20 mm Rotary types: 10% ØN

Law	Tap	Ø Z	RZ (nom.)	Contact resistance
B2	Z2	50% Ø N ± 5%	10% RT	$\leq 1.10^{-2} RZ2^*$
		20 mm Rotary without switch types = 57% Ø N ± 5% with switch types = 52% Ø N ± 5%		

* Minimum value: 10Ω

Obtainable resistance laws are specified on the pages describing each potentiometer type.



Resistance Law

Loi de variation de la résistance

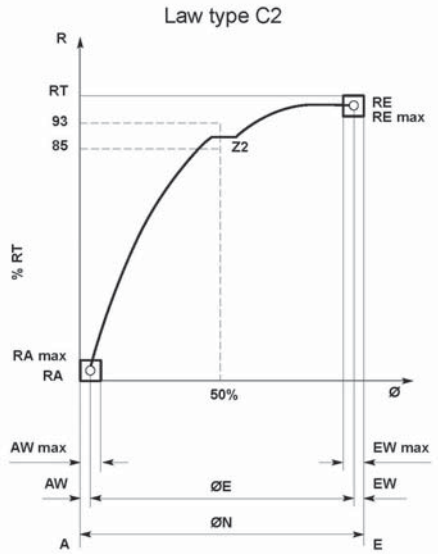
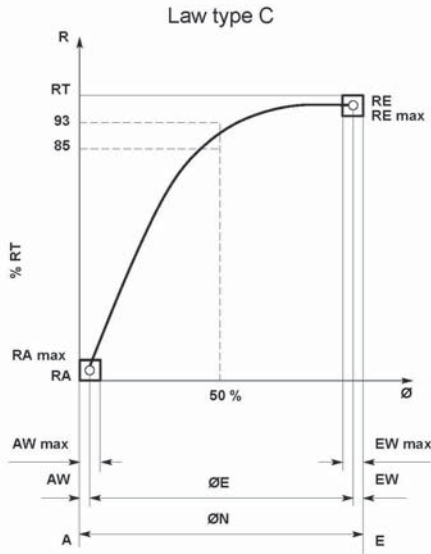

Rotary types: clockwise rotation.

Slider types: travel from A towards E termination.

Law	Ra	Re	RA	RE	AW max	EW max
C	$RN \leq 100K \leq 2.10^{-2} RN$	$RN \leq 10K \leq 1.10^{-3} RN^*$	$\leq 5.10^{-2} RN$	$RN < 10K \leq 5.10^{-3} RN$	7% $\varnothing N$ (1)	
C2	$RN > 100K \leq 1.10^{-2} RN$	$RN > 10K \leq 2.10^{-4} RN^*$		$RN \geq 10K \leq 1.10^{-3} RN$		

* Minimum values: $RN \leq 10K = 2\Omega$; $RN > 10K = 10\Omega$

(1) 20 mm Rotary types: 10% $\varnothing N$

Law	Tap	$\varnothing Z$	RZ (nom.)	Contact resistance
C2	Z2	50% $\varnothing N \pm 5\%$	90% RT	$\leq 1.10^{-2} RZ2^*$

* Minimum value: 10 Ω

Obtainable resistance laws are specified on the pages describing each potentiometer type.



Law type F

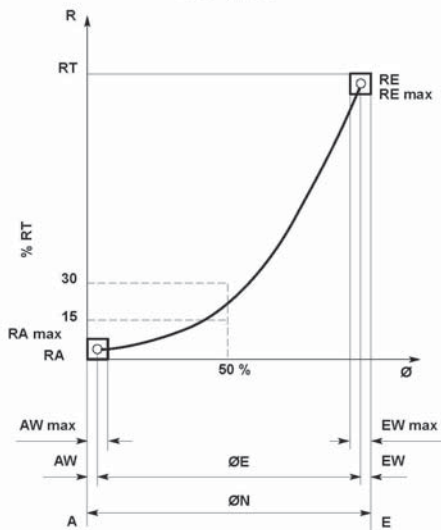

Law type T

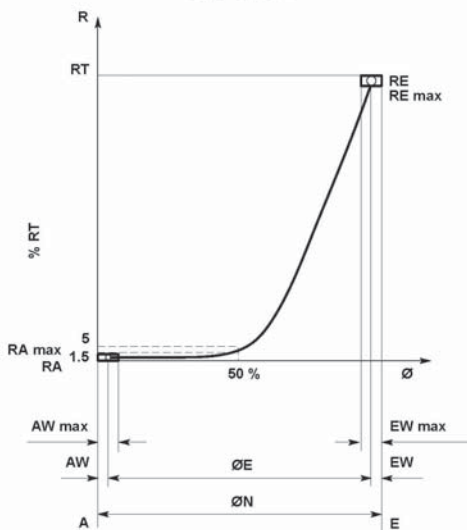

Rotary types: clockwise rotation.

Slider types: travel from A towards E termination.

2K2 to 100K for 16 mm Rotary types
10K to 1M0 for other type

Law	Ra	Re	RA	RE	AW max	EW max
F	$RN \leq 10K \leq 1.10^{-3} RN^*$ $RN > 10K \leq 2.10^{-4} RN^*$	$RN \leq 100K \leq 2.10^{-2} RN$	$RN < 10K \leq 5.10^{-3} RN$ $RN \geq 10K \leq 1.10^{-3} RN$	$\leq 5.10^{-2} RN$	7% Ø N (1)	
T	$\leq 2.10^{-4} RN^*$	$RN > 100K \leq 1.10^{-2} RN$	$\leq 1.10^{-3} RN$			

* Minimum values: $RN \leq 10K = 2\Omega$; $RN > 10K = 10\Omega$

(1) 20 mm Rotary types: 10% ØN

Obtainable resistance laws are specified on the pages describing each potentiometer type.



Law type S

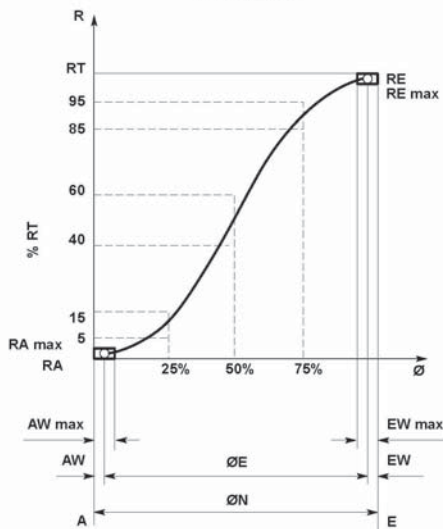

Law type S2

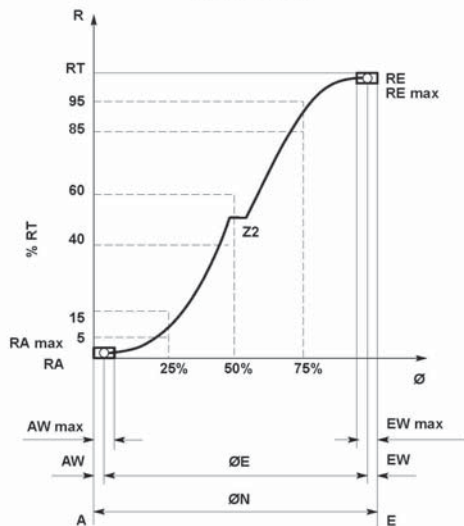

Rotary types: clockwise rotation.

Slider types: travel from A towards E termination.

Law	Ra	Re	RA	RE	AW max	EW max
S	$\leq 1.10^{-3} RN^*$	$\leq 1.10^{-3} RN^*$	$\leq 1.10^{-2} RN$	$\leq 1.10^{-2} RN$	7% $\varnothing N$ (1)	
S2						

* Minimum values: 2Ω

(1) 20 mm Rotary types: AW max = 12% $\varnothing N$; EW max = 10% $\varnothing N$

Law	Tap	$\varnothing Z$	RZ (nom.)	Contact resistance
S2	Z2	50% $\varnothing N \pm 5\%$	50% RT	$\leq 1.10^{-2} RZ^*$

* Minimum value: 10Ω

Obtainable resistance laws are specified on the pages describing each potentiometer type.



Resistance Law

Loi de variation de la resistance

NEW

Law type X

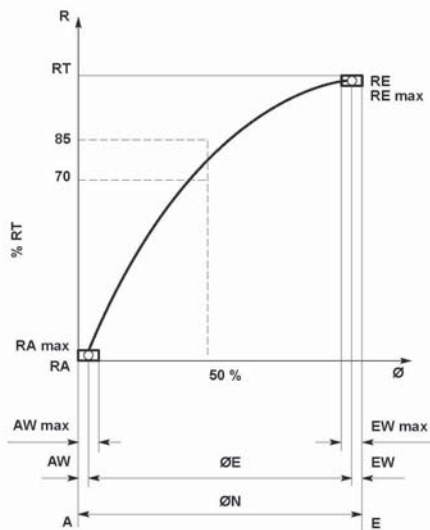

Law types B5 - B15 - B25 - B30

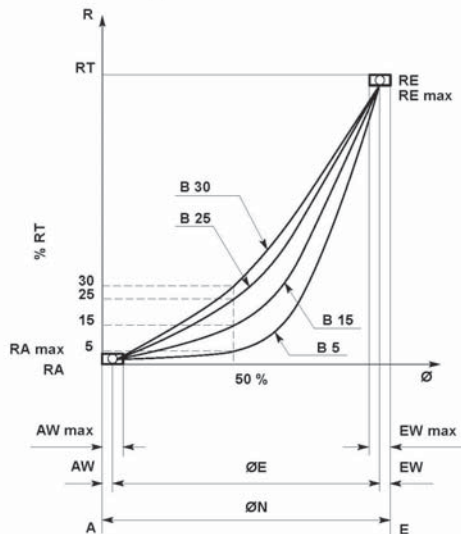

Rotary types: clockwise rotation.

Slider types: travel from A towards E termination.

Only for potentiometer types:

CIP162 - P162 - EP162 - SP162

Law	Ra	Re	RA	RE	AW max	EW max
X	$RN \leq 100K \leq 2 \cdot 10^{-2} RN$ $RN > 100K \leq 1 \cdot 10^{-2} RN$	$RN \leq 10K \leq 1 \cdot 10^{-3} RN^*$ $RN > 10K \leq 2 \cdot 10^{-4} RN^*$	$\leq 5 \cdot 10^{-2} RN$	$RN < 10K \leq 5 \cdot 10^{-3} RN$ $RN \geq 10K \leq 1 \cdot 10^{-3} RN$	7% Ø N (1)	

* Minimum values: $RN \leq 10K = 2\Omega$; $RN > 10K = 10\Omega$

(1) 20 mm Rotary types: 10% ØN

Law	Ra	Re	RA	RE	AW max	EW max
B5 - B15	$RN \leq 10K \leq 1 \cdot 10^{-3} RN^*$	$RN \leq 100K \leq 2 \cdot 10^{-2} RN$	$RN < 10K \leq 5 \cdot 10^{-3} RN^*$	$\leq 5 \cdot 10^{-2} RN$	7% Ø N	
B25-B30	$RN > 10K \leq 2 \cdot 10^{-4} RN^*$	$RN > 100K \leq 1 \cdot 10^{-2} RN$	$RN \geq 10K \leq 1 \cdot 10^{-3} RN^*$			

* Minimum values: $RN \leq 10K = 2\Omega$; $RN > 10K = 10\Omega$

Obtainable resistance laws are specified on the pages describing each potentiometer type.

Circuit

Normally a potentiometer is utilized in the voltage-divider circuit arrangement A. The current-regulation configuration B is for use in special cases only, because contact resistance between resistance element and sliding arm could pose a problem.

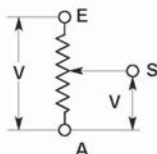

Fig. A
Voltage divider type

Terminations connecting

In applying DC current to potentiometer, the circuit configuration shows in C is recommended.

Circuit configuration in D should be avoided because it will cause abnormal variations in resistance.

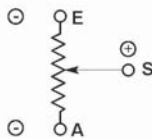

Fig. C
Right

Terminations soldering

It is important that terminations soldering be done carefully at a solder temperature of 350°C, within a period of 3 seconds.

Circuit

Un potentiomètre est utilisé normalement comme diviseur de tension (fig. A).

Le montage en régulateur de courant (fig. B) doit être utilisé que dans des cas particuliers, car la résistance de contact entre la piste résistive et le curseur peut dans cette application poser un problème.

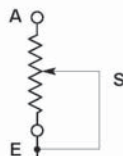

Fig. B
Current regulator type

Connexion des cosses

En cas d'utilisation du potentiomètre en courant continu, il est recommandé d'utiliser le circuit fig. C.

Le circuit fig. D doit être évité car il peut causer des variations irrégulières de la résistance.

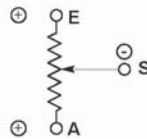

Fig. D
Wrong

Soudure des cosses

Il est important que la soudure des cosses soit faite avec soin à la température de 350°C pendant un temps de 3 secondes.



0.1 W - 10 mm size	<i>0,1 W - Diam. 10 mm</i>
0.1 W - 10 mm size Plastic case, screwdriver slot	<i>0,1 W - Diam 10 mm Boiter plastique, fente tournevis</i>
0.1 W - 10 mm size Plastic case, spindle slot	<i>0,1 W - Diam 10 mm Boiter plastique, fente pour axe</i>
0.2 W - 15 mm size Plastic case, screwdriver slot	<i>0,2 W - Diam. 15 mm Boiter plastique, fente tournevis</i>
0.2 W - 15 mm size Plastic case, spindle slot	<i>0,2 W - Diam. 15 mm Boiter plastique, fente pour axe</i>
Multiturn Carbon Presets	<i>Ajustable multitours à carbone</i>
Wirewound Presets	<i>Ajustable bobinés</i>
How to order	<i>Désignation pour passer une commande</i>



Carbon Preset Potentiometers

0,1 W - 10 mm size

Types
PR10 H
PR10 V

Mechanical data

Rotation angle:	$220^{\circ}C \pm 5^{\circ}$
Operating torque:	0.4 ± 2 Ncm
Permissible torque at end stop:	4 Ncm max
Weight:	~ 0.5 g

Electrical data

Rated dissipation @ 40°C:	0.1 W
Limiting element voltage:	250 VDC
Rated resistance:	100R to 4M7
• standard:	E3 Series
• optional:	E6 Series
Tolerance on rated resistance:	
• 100R to 1M0:	$\pm 20\%$
• over 1M0:	$\pm 30\%$
• optional (1K0 to 1M0):	$\pm 10\%$
Resistance law:	linear A

Screwdriver operation



PR10H

Horizontal mounting

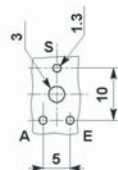
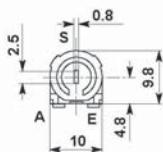
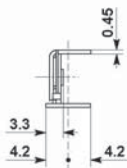

viewed on
component side



PR10V

Vertical mounting

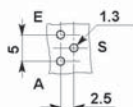
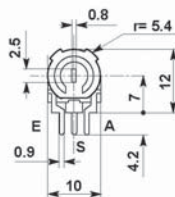
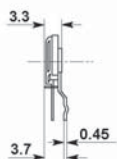

viewed on
component side



Carbon Preset Potentiometers

0,1 W - 10 mm size

Plastic Case

Types
T10 FH
T10 FV

Mechanical data

Rotation angle:	$270^\circ \pm 5^\circ$
Operating torque:	$0.4 \pm 2 \text{ Ncm}$
Permissible torque at end stop:	10 Ncm max
Weight:	$\sim 0.5 \text{ g}$

Switch version

Available as switch SPDT: see scheme and data below.

Types: **T10 FH SPDT; T10 FV SPDT**

Electrical data

Rated dissipation @ 40° :	0.1 W
Limiting element voltage:	250 VDC
Rated resistance:	100R to 4M7
• standard:	E3 Series
• optional:	E6 Series
Tolerance on rated resistance:	
• 100R to 1M0	$\pm 20\%$
• over 1M0	$\pm 30\%$
• optional (1K0 to 1M0):	$\pm 10\%$
Resistance law:	linear A

NEW



T10 FH

Horizontal mounting

Insulated screwdriver slot.

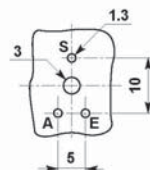
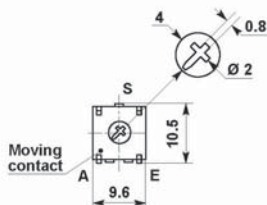
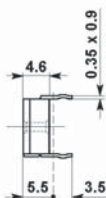

viewed on component side



T10 FV

Vertical mounting

Insulated screwdriver slot.

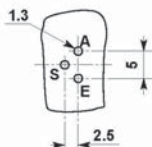
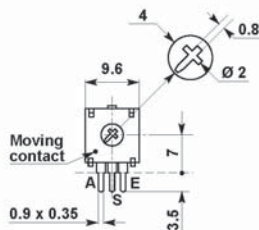
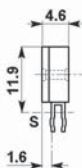

viewed on component side

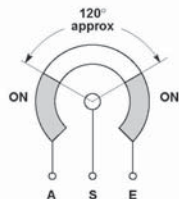

Switch scheme

Breaking capacity: 15 mA - 24 VDC

Resistance: 10 Ω max

Drawings show the moving contact in full anti-clockwise position (start of travel).



Carbon Preset Potentiometers

0,1 W - 10 mm size

Plastic Case

Type
T10 H

Mechanical data

Rotation angle: $270^\circ \pm 5^\circ$
 Operating torque: 0.4 ± 2 Ncm
 Permissible torque at end stop: 10 Ncm max
 Weight: ~ 0.5 g

Switch version

Available as switch SPDT: see scheme and data at p. 40.
 Type: T10 H SPDT

Electrical data

Rated dissipation @ 40° : 0.1 W
 Limiting element voltage: 250 VDC
 Rated resistance: 100R to 4M7
 • standard: E3 Series
 • optional: E6 Series
 Tolerance on rated resistance:
 • 100R to 1M0: $\pm 20\%$
 • over 1M0: $\pm 30\%$
 • optional (1K0 to 1M0): $\pm 10\%$
 Resistance law: linear A



T10 H

Horizontal mounting
Spindle slot

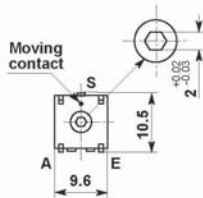
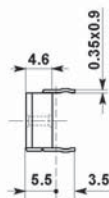

Drawing shows the moving contact in the middle of travel.

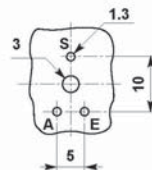

viewed on component side

Plastic spindle type P 10

A snap-in plastic spindle, available on request, can be inserted, both sides, after the potentiometer has been soldered on the printed circuit board.

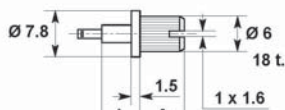

F310 A = 7.5 mm
F320 A = 12.5 mm

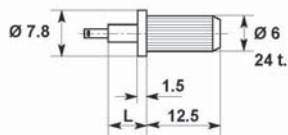

F350

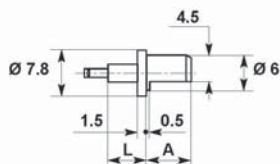

F330 A = 7 mm
F340 A = 12 mm

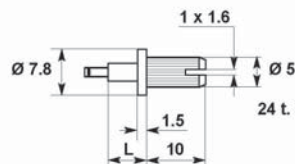

F360

Available lengths: L = 2 - 5 - 9 - 14 - 19 - 24 mm

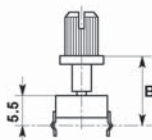

L = mm	2	5	9	14	19	24
B = mm	8	11	15	20	25	30
C = mm	0	3	7	12	17	22

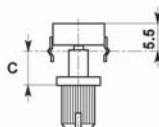



Carbon Preset Potentiometers

0,1 W - 10 mm size

Plastic Case

Type
T10 V

Mechanical data

Rotation angle: $270^\circ \pm 5^\circ$
 Operating torque: 0.4 ± 2 Ncm
 Permissible torque at end stop: 10 Ncm max
 Weight: ~ 0.5 g

Switch version

Available as switch SPDT: see scheme and data at p. 40.
 Type: T10 V SPDT

Electrical data

Rated dissipation @ 40° : 0.1 W
 Limiting element voltage: 250 VDC
 Rated resistance: 100R to 4M7
 • standard: E3 Series
 • optional: E6 Series
 Tolerance on rated resistance:
 • 100R to 1M0: $\pm 20\%$
 • over 1M0 $\pm 30\%$
 • optional (1K0 to 1M0): $\pm 10\%$
 Resistance law: linear A

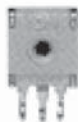

T10 V

Vertical mounting
 Spindle slot

viewed on
 component side

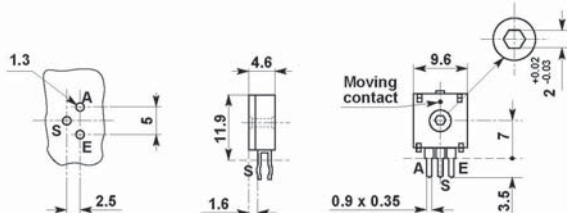

Drawing shows the moving contact in the middle of travel.

Plastic spindle type P 10

A snap-in plastic spindle, available on request, can be inserted, both sides, after the potentiometer has been soldered on the printed circuit board.

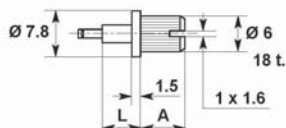

F310 A = 7.5 mm
 F320 A = 12.5 mm

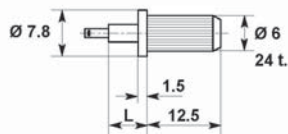

F350

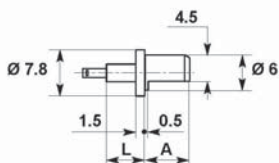

F330 A = 7 mm
 F340 A = 12 mm

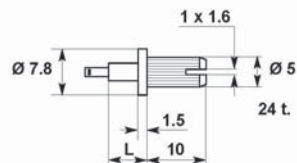

F360

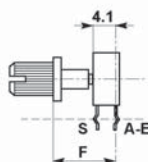

Available lengths: L = 2 - 5 - 9 - 14 - 19 - 24 mm

L = mm	2	5	9	14	19	24
F = mm	6	9	13	18	23	28
G = mm	1,5	4,5	8,5	13,5	18,5	23,5

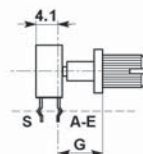



Carbon Preset Potentiometers

0,2 W - 15 mm size Plastic Case

Types
TR15FH
TR15FV 10

Mechanical data

Rotation angle: $240^\circ \pm 5^\circ$
 Operating torque: $0.5 + 3.5 \text{ Ncm}$
 Permissible torque at end stop: 10 Ncm max
 Weight: $\sim 1.5 \text{ g}$

Switch version

Available as switch SPDT: see scheme and data below.

Types: TR15FH 12.5 SPDT; TR15FH 15 SPDT;
 TR15FH 17.5 SPDT

Electrical data

Rated dissipation @ 40° : 0.2 W
 Limiting element voltage: 350 VDC
 Rated resistance: $100\text{R to } 4\text{M}\Omega$
 • standard: E3 Series
 • optional: E6 Series
 Tolerance on rated resistance:
 • 100R to 1M Ω : $\pm 20\%$
 • over 1M Ω : $\pm 30\%$
 • optional (1K Ω to 1M Ω): $\pm 10\%$
 Resistance law: linear A



TR15FH
 Horizontal mounting
 Insulated screwdriver slot

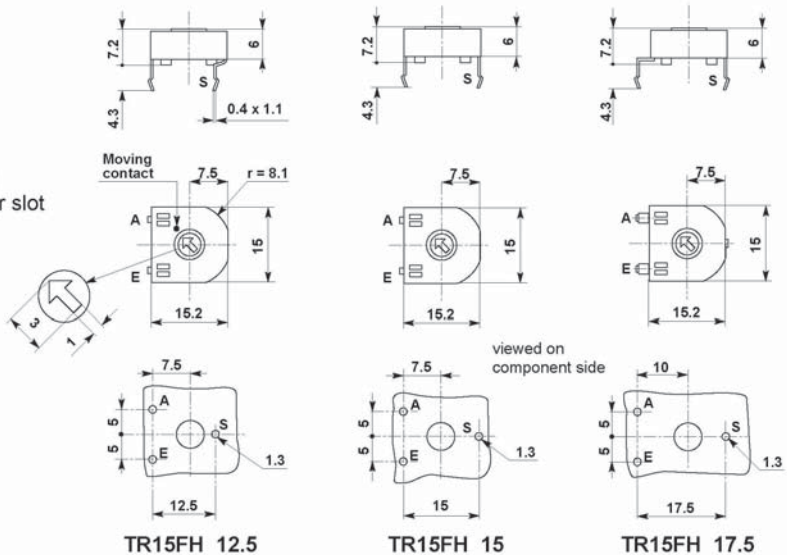

Drawings show the moving contact in full anti-clockwise position (start of travel).



TR15FV 10
 Vertical mounting
 Insulated screwdriver slot

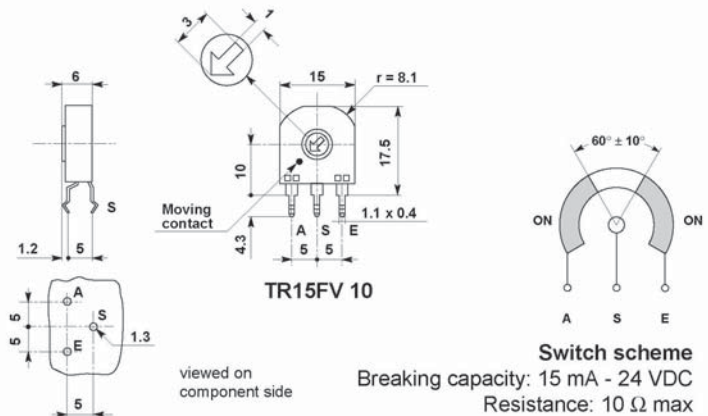

Switch scheme
 Breaking capacity: $15 \text{ mA} - 24 \text{ VDC}$
 Resistance: $10 \Omega \text{ max}$



Carbon Preset Potentiometers

0,2 W - 15 mm size

Plastic Case

Types
P15H

Mechanical data

Rotation angle: $240^\circ \pm 5^\circ$
 Operating torque: $0,5 \pm 3,5$ Ncm
 Permissible torque at end stop: 10 Ncm max
 Weight: $\sim 1,5$ g

Switch version

Available as switch SPDT: see scheme and data at p. 43.

Types: **P15H 12.5 SPDT; P15H 15 SPDT; P15H 17.5 SPDT**

Electrical data

Rated dissipation @ 40°C: 0.2 W
 Limiting element voltage: 350 VDC
 Rated resistance: 100R to 4M7
 • standard: E3 Series
 • optional: E6 series
 Tolerance on rated resistance:
 • 100R to 1M0: $\pm 20\%$
 • over 1M0: $\pm 30\%$
 • optional (1K0 to 1M0): $\pm 10\%$
 Resistance law: linear A

NEW



P15H

Horizontal mounting

Standard spindle slot

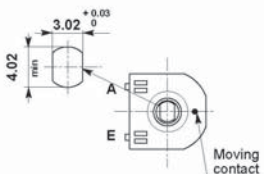
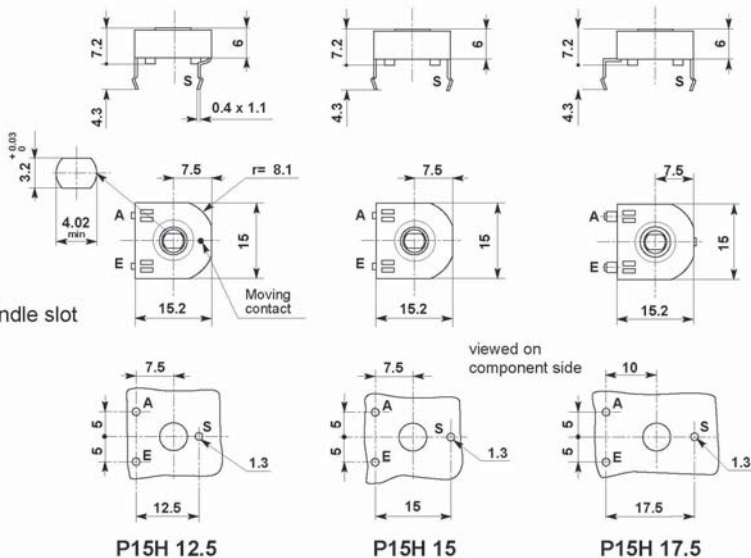

Optional spindle slot

Drawings show the moving contact in the middle of travel.

Plastic spindles type P15

A snap-in plastic spindle, available on request, can be inserted, both sides, after the potentiometer has been soldered on the printed circuit board.

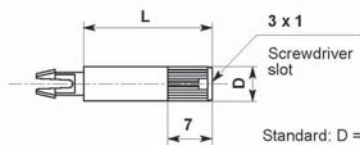

D = 4 mm; without screwdriver slot

Standard: D = 6 mm L = 50 mm
 Available: D = 6 mm L = 8-12-14-20-30-40-60 mm
 D = 4 mm L = 14-20-30-40-50-60 mm

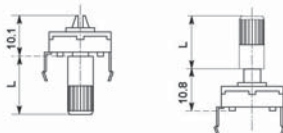



Carbon Preset Potentiometers

0,2 W - 15 mm size

Plastic Case

Type
P15V 10

Mechanical data

Rotation angle: $240^\circ \pm 5^\circ$
 Operating torque: $0.5 \div 3.5$ Ncm
 Permissible torque at end stop: 35 Ncm max
 Weight: ~ 1.5 g

Switch version

Available as switch SPDT: see scheme and data at p. 43.
 Type: P15V 10 SPDT

Electrical data

Rated dissipation @ 40°C : 0.2 W
 Limiting element voltage: 350 VDC
 Rated resistance: 100R to 4M7
 • standard: E3 Series
 • optional: E6 Series
 Tolerance on rated resistance:
 • 100R to 1M0: $\pm 20\%$
 • over 1M0: $\pm 30\%$
 • optional (1K0 to 1M0): $\pm 10\%$
 Resistance law: linear A



P15V 10

Vertical mounting

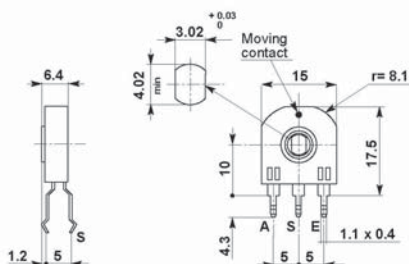

Standard spindle slot

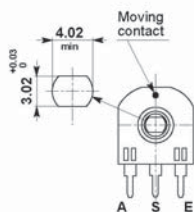

Optional spindle slot

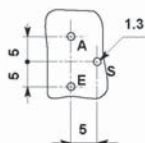

viewed on component side

Drawings show the moving contact in the middle of travel.

Plastic spindle type P15

A snap-in plastic spindle, available on request, can be inserted, both sides, after the potentiometer has been soldered on the printed circuit board.

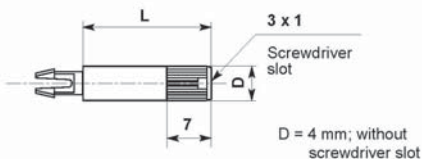

D = 4 mm; without screwdriver slot

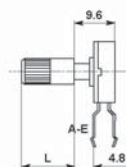
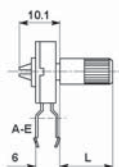

Standard: D = 6 mm L = 50 mm
 Available: D = 6 mm L = 8-12-14-20-30-40-60 mm
 D = 4 mm L = 14-20-30-40-50-60 mm



Mechanical data

Travel: 25 mm
 Operating torque: 0.3 ± 1 Ncm
 Permissible axial spindle load: 2.5 N max
 Life: 5,000 cycles
 Weight: ~3 g

Electrical data

Rated dissipation @ 40°C: 0.25 W linear law
 0.15 W non-linear law
 Limiting element voltage: 350 VDC
 Rated resistance: 100R to 4M7
 • standard: E3 series
 • optional: E6 series
 Tolerance on rated resistance:
 • 100R to 1M0: $\pm 20\%$
 • over 1M0: $\pm 30\%$
 • optional (1K0 to 1M0): $\pm 10\%$
 Resistance law: linear A
 Varicap TV tuner law 100 KV

Precision preset potentiometers

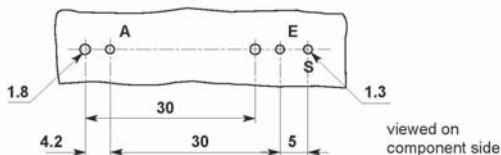
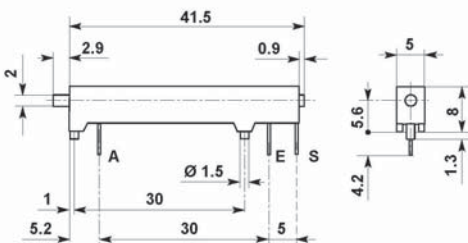

Indicator variations

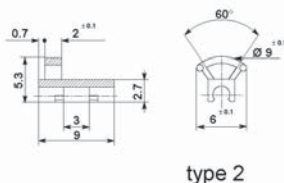
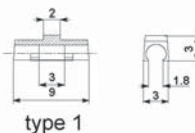

Knob variations

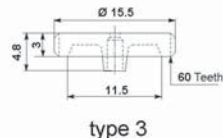
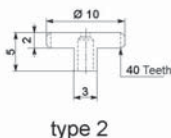
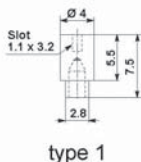

Types	Turns	Rotation (1)
PM10	10	CCW
PM18	18	CW
PM25	25	CCW
PM40	40	CCW

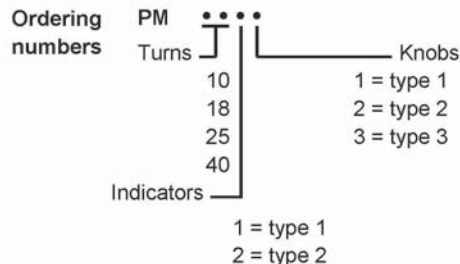

(1) Increasing resistance value between A and S terminations.

Standard type: PM 4011



Wirewound Preset Potentiometers

3 W - 20 mm size

Types
PB3
PB3A

Mechanical data

Rotation angle: $260^\circ \pm 5^\circ$
 Operating torque: 0.5 ± 3.5 Ncm
 Permissible torque at end stop: 20 Ncm max
 Weight: ~ 6 g

Electrical data

Rated dissipation @ 40°C : 3 W
 Insulation voltage: 300 VAC
 Rated resistance: 3R3 to 2K2 E12 Series
 Tolerance on rated resistance:
 3R3 to 4R7: $\pm 20\%$
 6R8 to 2K2: $\pm 10\%$
 Resistance law: linear A
 Tap: at 50% of rotation
 Operating temperature: -25°C to $+90^\circ\text{C}$

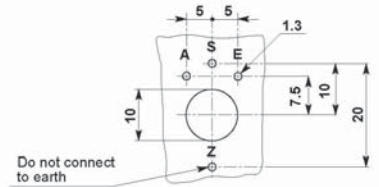
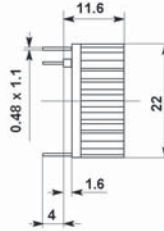
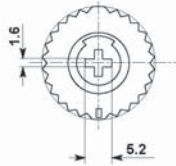

Types

PB3	Without tap
PB3 P	With tap

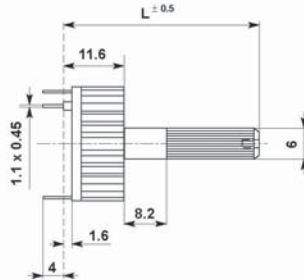
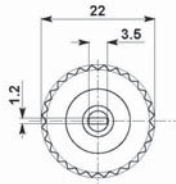

viewed on component side

Types

PB3 A	Without tap
PB3 AP	With tap

Derating curve

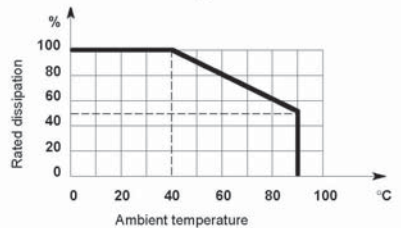

Available spindles - for PB3A & PB3AP
 Standard: L = 50 mm
 Optional: L = 25-28-33-40-45-55-60-64-71 mm



How to order

Désignation pour passer une commande

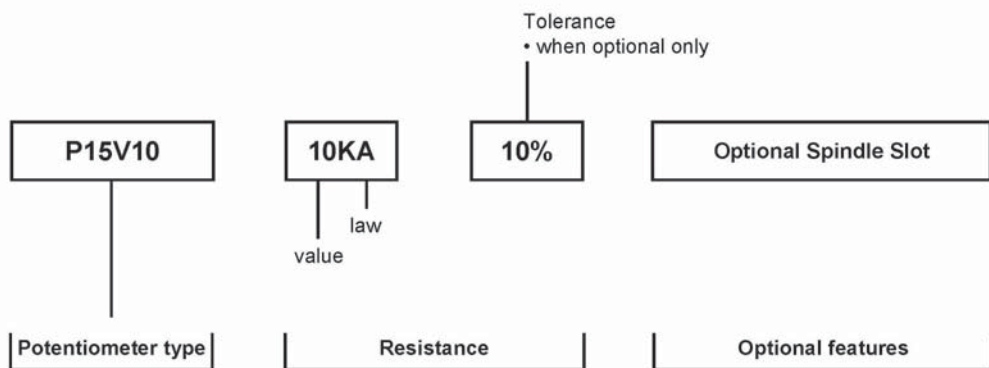

• Resistance law: see p. 29.

Available resistance values, resistance law, optional tolerance and optional features are specified on the pages describing each preset type.



Singles

Singles with Socket

Ganged-stereo

Ganged-multiples

Duals

Dual-multiples

Simples

Simples avec étrier

Jumelés stéréo

Jumelés multiples

Doubles

Doubles multiples

With Rotary Switch

With Push-push Switch

Avec interrupteur rotatif

Avec interrupteur push-push

Click-stops types

Dust-proof types

Edge Control Potentiometers

Types avec cran de position

Types étanche à la poussière

Potentiomètres à molette

Mounting Bushes

Spindle variations

Normalised spindles

Position of the taps

Mounting accessories

Canons de montage

Variations de l'axe

Axes normalisés

Position des prises

Ecrous et rondelles

How to order

Désignation pour passer une commande



Mechanical data

Rotation angle:	270° ± 5°
Operating torque:	0.4 ÷ 1.5 Ncm
Permissible torque at end stop:	35 Ncm max
Permissible axial spindle load:	50 N (5 sec max)
Tap:	Z2 at 50% of rotation
Weight, std. spindle:	~ 6 g

Optional features

- Central click
- Rotation angle 300° ± 5°: types CIP162C and P162C
- 11 click-stops: types CIR11P162C and R11P162C

Electrical data

Rated dissipation @ 40°C:	0.25 W linear law 0.12 W non-linear law
Limiting element voltage:	350 VDC
Insulation resistance:	≥ 5 GΩ
Insulation voltage:	500 VAC
Rated resistance: E3 Series; optional E6 Series	
• linear law:	100R to 4M7
• non-linear law:	1K0 to 2M2
Tolerance on rated resistance:	
• 100R to 1M0:	± 20%
• over 1M0:	± 30%
• optional (1K0 to 1M0):	± 10%
Resistance law:	A, B, C, F, T, S, X A2, B2, C2, S2
• with tap:	
• CIP162C, P162C:	B5, B15, B25, B30

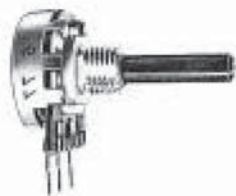

viewed on component side

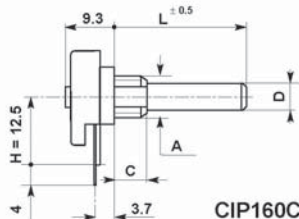
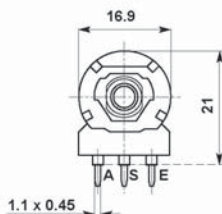

CIP160C

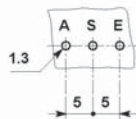

Optional terminations

- H = 15 mm
- 9.3 mm instead of 4 mm for H = 12.5 only

Types

CIP160C	P.c. terminations
P160C	Solder tag terminations

Standard spindle & bush

D = 4 mm; L = 32 mm, plastic, F21 type
A = M7x0.75; C = 6 mm, C type

Spindle and bushing variations

D mm	Available types				
	Plastic spindle	Metal spindle	Bush	C = mm	A = mm
4	F21, F22, F23, F25	M21, M22, M23, M25	C, CE	6 - 9	M7x0.75
			CEP	4.5 - 8	M7x0.75
6	F31, F32, F33, F34, F35	M31, M32, M33, M34, M35	C, CE	6 - 9	M7x0.75
			CEP	4.5 - 8	M7x0.75
	F1, F2, F3, F4, F5, F6, F10, F11, F12	NOT	KC	8	M10x0.75
			C9	6	M9x0.75

Spindle and bushing details, chassis piercing: see p. 79 to 83.

Normalised spindles: see p. 84.



Mechanical data

Rotation angle: $270^\circ \pm 5^\circ$
 Operating torque: 0.4 ± 1.5 Ncm
 Permissible torque at end stop: 35 Ncm max
 Permissible axial spindle load: 50 N
 (5 sec max)
 Tap: Z2 at 50% of rotation
 Weight, std. spindle: ~ 6 g

Optional features

- Central click
- Rotation angle $300^\circ \pm 5^\circ$: type CIP163C
- 11 click-stops: type CIR11P163C

Electrical data

Rated dissipation @ 40°C: 0.25 W linear law
 0.12 W non-linear law
 Limiting element voltage: 350 VDC
 Insulation resistance: ≥ 5 GΩ
 Insulation voltage: 500 VAC
 Rated resistance: E3 Series; optional E6 Series
 • linear law: 100R to 4M7
 • non-linear law: 1K0 to 2M2
 Tolerance on rated resistance:
 • 100R to 1M0: $\pm 20\%$
 • over 1M0: $\pm 30\%$
 • optional (1K0 to 1M0): $\pm 10\%$
 Resistance law: A, B, C, F, T, S, X
 • with tap: A2, B2, C2, S2

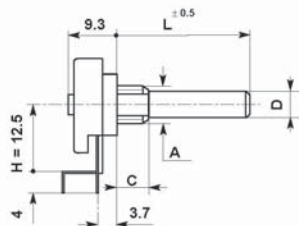
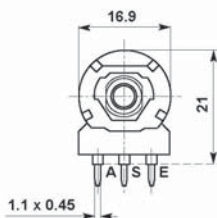
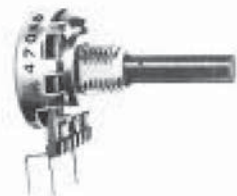

viewed on
component side

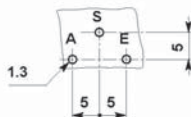

CIP161 C

Standard spindle & bush

D = 4 mm; L = 32 mm, plastic, F21 type
 A = M7x0.75; C = 6 mm, C type

Spindle and bushing variations

D mm	Available types				
	Plastic spindle	Metal spindle	Bush	C = mm	A = mm
4	F21, F22, F23, F25	M21, M22, M23, M25	C, CE	6 - 9	M7x0.75
			CEP	4.5 - 8	M7x0.75
6	F31, F32, F33, F34, F35	M31, M32, M33, M34, M35	C, CE	6 - 9	M7x0.75
			CEP	4.5 - 8	M7x0.75
	F1, F2, F3, F4, F5, F6, F10, F11, F12	NOT	KC	8	M10x0.75
			C9	6	M9x0.75

Spindle and bushing details, chassis piercing: see p. 79 to 83.

Normalised spindles: see p. 84.



Carbon Rotary Potentiometers - 16 mm size

Singles

Plastic Case

Types
CIP160KC
P160KC

Mechanical data

Rotation angle: $270^\circ \pm 5^\circ$
 Operating torque: $0.4 \div 1.5$ Ncm
 Permissible torque at end stop: 60 Ncm max
 Permissible axial spindle load: 100 N
 (5 sec max)
 Tap: Z2 at 50% of rotation
 Weight, std. spindle: ~ 6 g

Optional features

- Rotation angle $300^\circ \pm 5^\circ$: types CIP162KC and P162KC
- Central click, for CIP160KC and P160KC types only; case dimension 13.8 mm instead 8.6 mm
- Earth termination for metal case type

Electrical data

Rated dissipation @ 40°C : 0.25 W linear law
 0.12 W non-linear law
 Limiting element voltage: 350 VDC
 Insulation resistance: ≥ 5 G Ω
 Insulation voltage: 500 VAC
 Rated resistance: E3 Series; optional E6 Series
 • linear law: 100R to 4M7
 • non-linear law: 1K0 to 2M2
 Tolerance on rated resistance:
 • 100R to 1M0: $\pm 20\%$
 • over 1M0: $\pm 30\%$
 • optional (1K0 to 1M0): $\pm 10\%$
 Resistance law: A, B, C, F, T, S, X
 With tap: A2, B2, C2, S2



H = 15 optional

Types

CIP160KC	P.c. terminations
P160KC	Solder tag terminations

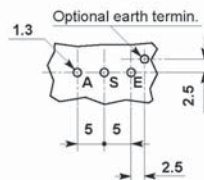
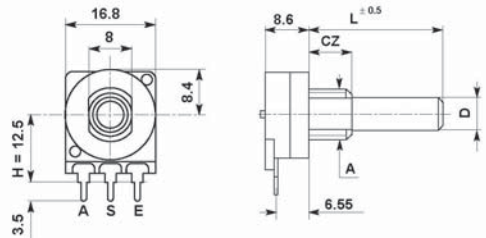

viewed on component side

CIP160KC

Standard spindle & bush

D = 6 mm, L = 50 mm, plastic, F1 type
 A = M10x0.75, CZ = 8 mm, KC type

Spindle and bushing variations

D mm	Available types				
	Plastic spindle	Metal spindle	Bush	A = mm	CZ = mm
4	F21, F22, F23, F25	M21, M22, M23, M25	KZ	M7 x 0.75	5-8-12
			KC	M10 x 0.75	8
6	F31, F32, F33, F34, F35	M31, M32, M33, M34, M35	KZ	M7 x 0.75	5-8-12
			KC	M10 x 0.75	8
	F1, F2, F3, F4, F5, F6, F10, F11, F12	M1, M2, M3, M4, M10, M11, M12	KZ	M10 x 0.75	5-8-12
			KC	M10 x 0.75	8

Spindle and bushing details, chassis piercing: see p. 79 to 83. - Normalised spindles: see p. 84.

These potentiometers are also available with metal case and bush (die-cast) as types CIP160ZC and P160ZC; bush type CZ or ZKC. All spindle variations and optional features are possible.



Mechanical data

Rotation angle: $300^\circ \pm 5^\circ$
 Operating torque: $1 \div 3$ Ncm
 Permissible torque at end stop: 35 Ncm max
 Permissible axial spindle load: 50 N
 (5 sec max)
 Weight, std. spindle: ~ 4 g

Electrical data

Rated dissipation @ 40°C : 0.25 W linear law
 0.12 W non-linear law
 Limiting element voltage: 350 VDC
 Insulation resistance: ≥ 5 G Ω
 Insulation voltage: 500 VAC
 Rated resistance: E3 Series optional E6 Series
 • linear law: 100R to 4M7
 • non-linear law: 1K0 to 2M2
 Tolerance on rated resistance:
 • 100R to 1M0: $\pm 20\%$
 • over 1M0: $\pm 30\%$
 • optional (1K0 to 1M0): $\pm 10\%$
 Resistance law: A, B, C, F, S, T, X
 B5, B15, B25, B30

NEW

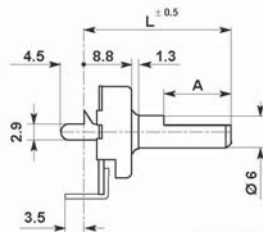
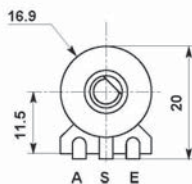

EP 162

Standard spindle

L = 30 mm, A = 12 mm
 F34 type

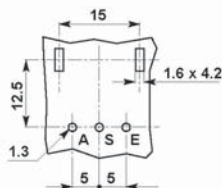

viewed on component side

Spindle variations

Plastic material

Type	L = mm	A = mm
F33	20	7
F34	25	12
	30	12
	35	12

spindle in full CCW position

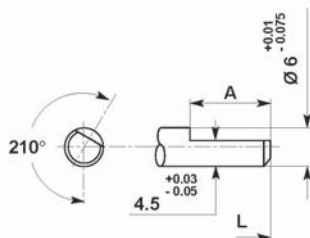



Mechanical data

Rotation angle: $270^\circ \pm 5^\circ$
 Operating torque: $0.4 \div 1.5$ Ncm
 Permissible torque at end stop: 35 Ncm max
 Permissible axial spindle load: 50 N
 (5 sec max)
 Weight, std. spindle: ~ 4 g

Optional feature

• Rotation angle $300^\circ \pm 5^\circ$: type **P162 BA**

Electrical data

Rated dissipation @ 40°C : 0.25 W linear law
 0.12 W non-linear law
 Limiting element voltage: 350 VDC
 Insulation resistance: ≥ 5 G Ω
 Insulation voltage: 500 VAC
 Rated resistance: E3 Series; optional E6 Series
 • linear law: 100R to 4M7
 • non-linear law: 1K0 to 2M2
 Tolerance on rated resistance:
 • 100R to 1M0: $\pm 20\%$
 • over 1M0: $\pm 30\%$
 • optional (1K0 to 1M0): $\pm 10\%$
 Resistance law: A, B, C, F, S, T, X

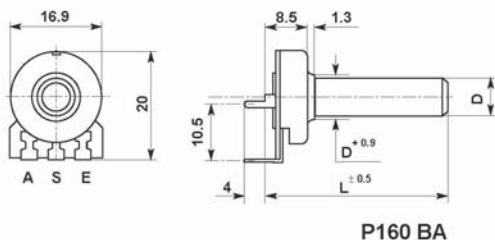
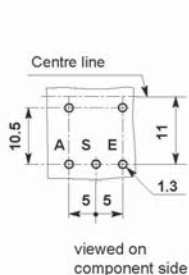

Standard spindle

L = 50 mm, plastic, F1 type
 D = 6 mm

Spindle minimum lengths

- F1 spindle type: L = 19 mm
- F5-F6 spindle types: L = 17 mm
- Others spindle types: L = 8 mm more than their minimum lengths

Spindle and bushing variations

D = mm	Available types	
	Plastic spindle	Metal spindle
6	F1, F2, F3, F4, F5, F6, F10, F11, F12	NOT
4	F21, F22, F 23	NOT

Spindle details: see p. 81 to 83.

Normalised spindles: see p. 84.



Carbon Rotary Potentiometers - 16 mm size

Singles Plastic Case

Types
EP160KC
EPP160KC

Mechanical data

Rotation angle: $270^\circ \pm 5^\circ$
 Operating torque: 0.4 ± 1.5 Ncm
 Permissible torque at end stop: 60 Ncm max
 Permissible axial spindle load: 100 N
 (5 sec max)
 Weight, std. spindle: ~ 6 g

Optional features

- Rotation angle $300^\circ \pm 5^\circ$: types EP162KC and EPP162KC
- Central click, for EP160KC and EPP160KC only

Electrical data

Rated dissipation @ 40°C : 0.25 W linear law
 0.12 W non-linear law
 Limiting element voltage: 350 VDC
 Insulation resistance: ≥ 5 G Ω
 Insulation voltage: 500 VAC
 Rated resistance: E3 Series; optional E6 Series
 • linear law: 100R to 4M7
 • non-linear law: 1K0 to 2M2
 Tolerance on rated resistance:
 • 100R to 1M0: $\pm 20\%$
 • over 1M0: $\pm 30\%$
 • optional (1K0 to 1M0): $\pm 10\%$
 Resistance law: A, B, C, F, T, S, X

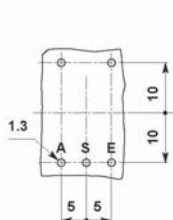

viewed on component side

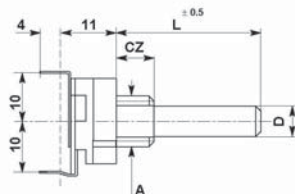
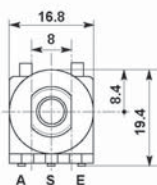
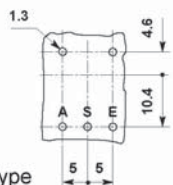

EP160 KC

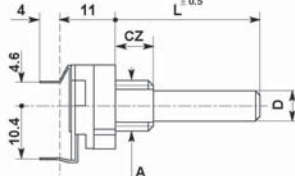
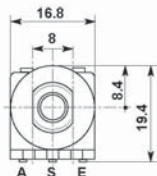

EPP160 KC

Standard spindle & bush

L = 50 mm, plastic, F1 type
 D = 6 mm
 A = M10x0.75, CZ = 8 mm, KC type

Spindle and bushing variations

D = mm	Available types				
	Plastic spindle	Metal spindle	Bush	A = mm	CZ = mm
4	F21, F22, F23, F25	M21, M22, M23, M25	KZ	M7 x 0.75	5-8-12
			KC	M10 x 0.75	8
6	F31, F32, F33, F34, F35 F1, F2, F3, F4, F5, F6, F10, F11, F12	M31, M32, M33, M34, M35 M1, M2, M3, M4, M10, M11, M12	KZ	M7 x 0.75	5-8-12
			KC	M10 x 0.75	8

Spindle and bushing details, chassis piercing: see p. 79 to 83. Normalised spindles: see p. 84.

These potentiometers are available also with metal case and bush (die-cast) as types EP160ZC and EPP160ZC; bush type CZ or ZKC. All spindle variations and optional features are possible.



Mechanical data

Rotation angle: $270^\circ \pm 5^\circ$
Operating torque: $0.4 \div 1.5$ Ncm
Permissible torque at end stop: 60 Ncm max
Permissible axial spindle load: 100 N
(5 sec max)

Weight, std. spindle: ~ 12 g

Optional features

- Rotation angle $300^\circ \pm 5^\circ$: types EP162Z and EPP162Z
- Central click, for EP160Z and EPP160Z only

Electrical data

Rated dissipation @ 40°C : 0.25 W linear law
0.12 W non-linear law
Limiting element voltage: 350 VDC
Insulation resistance: ≥ 5 G Ω
Insulation voltage: 500 VAC
Rated resistance: E3 Series; optional E6 Series
• linear law: 100R to 4M2
• non-linear law: 1K0 to 2M2
Tolerance on rated resistance:
• 100R to 1M0: $\pm 20\%$
• over 1M0: $\pm 30\%$
• optional (1K0 to 1M0): $\pm 10\%$
Resistance law: A, B, C, F, S, T, X

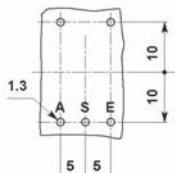
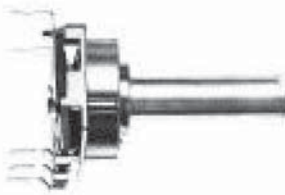

Viewed on component side

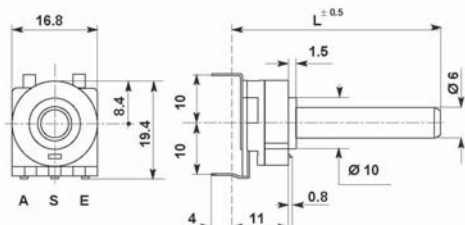
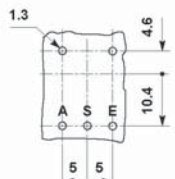

EP160Z

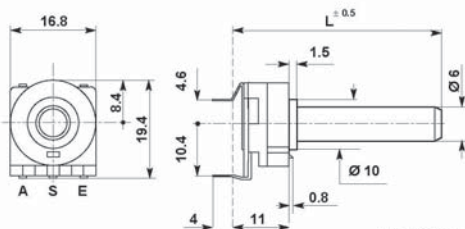

EPP160Z

Standard spindle

L = 51 mm, plastic, F1 type

Spindle variations

Available types	
Plastic spindle	Metal spindle
F1, F2, F3, F4, F5, F6	M1, M2, M3, M4
F10, F11, F12	M10, M11, M12

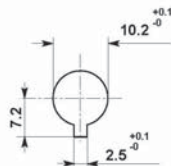

Spindle details: see p. 81 - 82.

Normalised spindles: see p. 84.

Chassis piercing



Carbon Rotary Potentiometers - 16 mm size

Singles

Plastic Case

Type
P160EKC

Mechanical data

Rotation angle:	$270^\circ \pm 5^\circ$
Operating torque:	0.4 ± 1.5 Ncm
Permissible torque at end stop:	60 Ncm max
Permissible axial spindle load:	100 N (5 sec max)

Weight, std. spindle: ~ 6 g

Optional features

- Rotation angle $300^\circ \pm 5^\circ$: type P162EKC
- Central click, for P160EKC only

Electrical data

Rated dissipation @ 40°C:	0.25 W linear law 0.12 W non-linear law
Limiting element voltage:	350 VDC
Insulation resistance:	≥ 5 G Ω
Insulation voltage:	500 VAC
Rated resistance: E3 Series; optional E6 Series	
• linear law:	100R to 4M7
• non-linear law:	1K0 to 2M2
Tolerance on rated resistance:	
• 100R to 1M0:	$\pm 20\%$
• over 1M0:	$\pm 30\%$
• optional (1K0 to 1M0):	$\pm 10\%$
Resistance law:	A, B, C, F, S, T, X

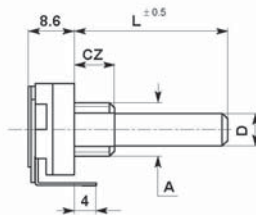
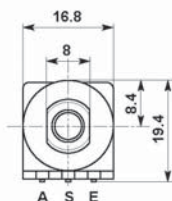
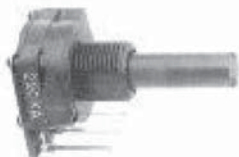

P160EKC

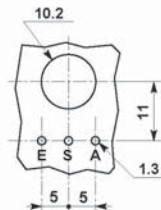

viewed on
component side

Standard spindle & bush

L = 50 mm, plastic, F1 type

D = 6 mm

A = M10x0.75, CZ = 8 mm, KC type

Spindle and bushing variations

D = mm	Available types				
	Plastic spindle	Metal spindle	Bush	A = mm	CZ = mm
4	F21, F22, F23, F25	M21, M22, M23, M25	KZ	M7 x 0.75	5-8-12
			KC	M10 x 0.75	8
6	F31, F32, F33, F34, F35 F1, F2, F3, F4, F5, F6, F10, F11, F12	M31, M32, M33, M34, M35 M1, M2, M3, M4, M10, M11, M12	KZ	M7 x 0.75	5-8-12
			KC	M10 x 0.75	8

Spindle and bushing details, chassis piercing: see p. 79 to 83.

Normalised spindles: see. 84.



Mechanical data

Rotation angle: $300^\circ \pm 5^\circ$
 Operating torque: $1 \div 3$ Ncm
 Permissible torque at end stop: 35 Ncm max
 Permissible axial spindle load: 50 N
 (5 sec max)

Weight, std. spindle: ~ 4

Electrical data

Rated dissipation @ 40°C: 0.25 W linear law
 0.12 W non-linear law
 Limiting element voltage: 350 VDC
 Insulation resistance: ≥ 5 GΩ
 Insulation voltage: 500 VAC
 Rated resistance: E3 Series; optional E6 Series
 • linear law: 100R to 4M7
 • non-linear law: 1K0 to 2M2
 Tolerance on rated resistance:
 • 100R to 1M0: $\pm 20\%$
 • over 1M0: $\pm 30\%$
 • optional (1K0 to 1M0): $\pm 10\%$
 Resistance law: A, B, C, F, S, T, X
 B5, B15, B25, B30

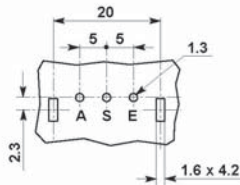
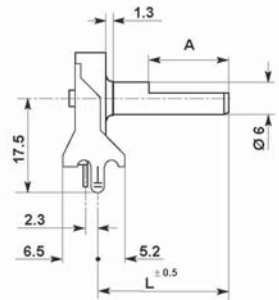
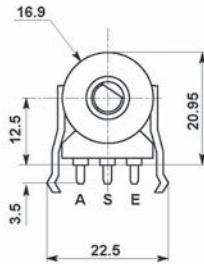

SP162

Standard spindle

L = 28.8 mm, plastic, A = 12 mm
 F34 type

viewed on
component side

Spindle variations

Plastic spindle

Type	L = mm	A = mm
F33	13.8	7
F34	18.8	12
	23.8	12
	28.8	12

spindle in full CCW position

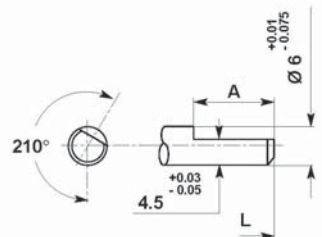



Carbon Rotary Potentiometers - 16 mm size

Singles

Die-cast Case

Type
P160ZCS

Mechanical data

Rotation angle:	270° ± 5°
Operating torque:	0.4 + 1.5 Ncm
Permissible torque at end stop:	60 Ncm max
Permissible axial spindle load:	100 N (5 sec max)
Tap:	Z2 at 50% of rotation
Weight, std. spindle:	~ 15 g

Optional features

- Rotation angle 300° ± 5°: type P162ZCS
- Central click, for P160ZCS only

Electrical data

Rated dissipation @ 40°C:	0.25 W linear law 0.12 W non-linear law
Limiting element voltage:	350 VDC
Insulation resistance:	≥ 5 GΩ
Insulation voltage:	500 VAC
Rated resistance: E3 Series; optional E6 Series	
• linear law:	100R to 4M7
• non-linear law:	1K0 to 2M2
Tolerance on rated resistance:	
• 100R to 1M0:	± 20%
• over 1M0:	± 30%
• optional (1K0 to 1M0):	± 10%
Resistance law:	A, B, C, F, S, T, X
• with tap:	A2, B2, C2, S2

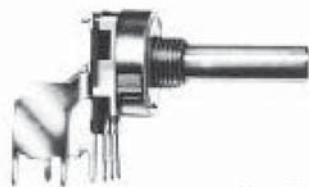

H = 15 optional

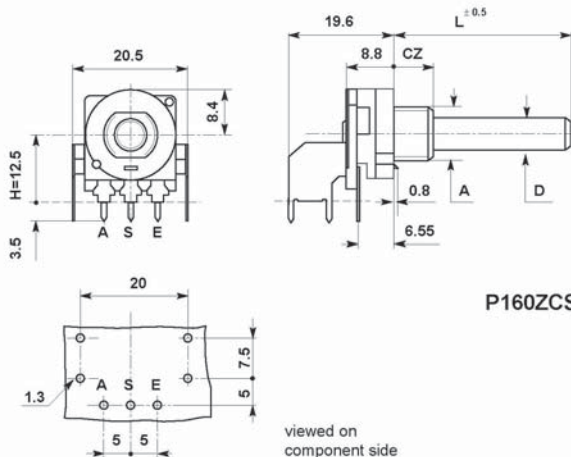

P160ZCS

Standard spindle & bush

L = 50 mm, plastic, F1 type

D = 6 mm

A = M10x0.75, CZ = 8 mm, CZ type

Spindle and bushing variations

D = mm	Available types				
	Plastic spindle	Metal spindle	Bush	A = mm	CZ = mm
4	F21, F22, F23, F25	M21, M22, M23, M25	CZ	M7 x 0.75	5-8-12
6	F31, F32, F33, F34, F35	M31, M32, M33, M34, M35	CZ	M7 x 0.75	5-8-12
	F1, F2, F3, F4, F5, F6, F10, F11, F12	M1, M2, M3, M4, M10, M11, M12	CZ	M10 x 0.75	5-8-12
			ZKC	M10 x 0.75	8

Spindle and bushing details, chassis piercing: see p. 79 to 83.

Normalised spindles: see p. 84.



Carbon Rotary Potentiometers - 16 mm size

Singles

Die-cast Case

Type
SP160Z

Mechanical data

Rotation angle:	270° ± 5°
Operating torque:	0.4 ÷ 1.5 Ncm
Permissible torque at end stop:	60 Ncm max
Permissible axial spindle load:	100 N (5 sec max)
Tap:	Z2 at 50% of rotation
Weight, std. spindle:	~ 15 g

Optional features

- Rotation angle 300° ± 5°: type SP162Z
- Central click, for SP160Z only

Electrical data

Rated dissipation @ 40°C:	0.25 W linear law	0.12 W non-linear law
Limiting element voltage:	350 VDC	
Insulation resistance:	≥ 5 GΩ	
Insulation voltage:	500 VAC	
Rated resistance: E3 Series; optional E6 Series		
• linear law:	100R to 4M7	
• non-linear law:	1K0 to 2M2	
Tolerance on rated resistance:		
• 100R to 1M0:	± 20%	
• over 1M0:	± 30%	
• optional (1K0 to 1M0):	± 10%	
Resistance law:	A, B, C, F, S, T, X	
• with tap:	A2, B2, C2, S2	

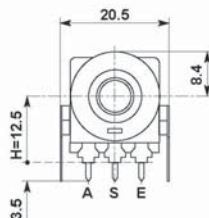
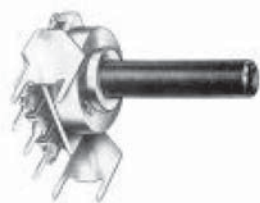

H = 15 optional

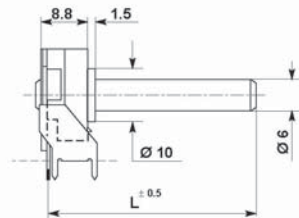

SP160Z

Standard spindle

L = 50 mm, plastic, F1 type

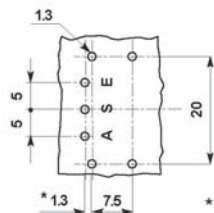

viewed on
component side

Spindle variations

Available types	
Plastic spindle	Metal spindle
F1, F2, F3, F4, F5, F6, F10, F11, F12	M1, M2, M3, M4, M10, M11, M12

Spindle details: see p. 81 - 82.

Normalised spindles: see p. 84.

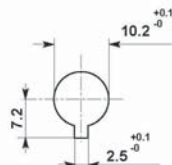

Chassis piercing



Mechanical data

Rotation angle:	290° ± 5°
Operating torque:	0.4 ± 1.5 Ncm
Permissible torque at end stop:	35 Ncm max
Permissible axial spindle load:	50 N (5 sec max)
Taps (1):	Z2 at 50% of rotation
Weight, std. spindle:	~ 9 g

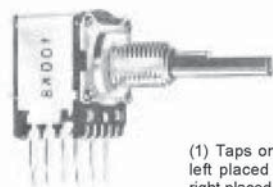

(1) Taps on P.c. terminations types: left placed on the first section and right placed on the second section, or vice versa.

Electrical data

Rated dissipation @ 40°C:	2 x 0.25 W linear law 2 x 0.12 W non-linear law
Limiting element voltage:	350 VDC
Insulation resistance:	≥ 5 GΩ
Insulation voltage:	500 VAC
Rated resistance: E3 Series; optional E6 Series	
• linear law:	100R to 4M7
• non-linear law:	1K0 to 2M2
Tolerance on rated resistance:	
• 100R to 1M0:	± 20%
• over 1M0:	± 30%
• optional (1K0 to 1M0):	± 10%
Resistance law:	A, B, C, F, S, T, X
• with tap:	A2, B2, C2, S2
Matching tolerance:	class II

Types

CIJP16C	P.c. terminations
JP16C	Solder tag terminations

Optional features

- Rotation angle of 270° ± 5°: types CIJP160C and JP160C
- Central click

Standard spindle & bush

- L = 32 mm, plastic, F21 type
- D = 4 mm
- C = 6 mm, C type

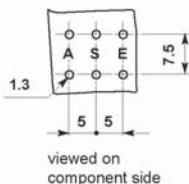
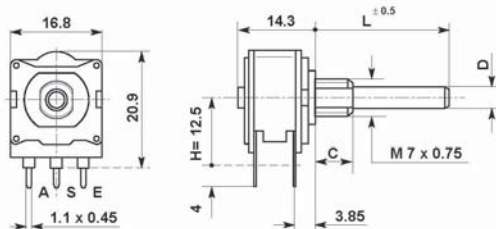

CIJP16C

Optional terminations

- H = 15 mm
- 9.3 mm length instead of 4 mm for H = 12.5 only
- 5 mm pitch instead of 7.5 mm

Spindle and bushing variations

D mm	Available types			
	Plastic spindle	Metal spindle	Bush	C = mm
4	F21, F22, F23, F25	M21, M22, M23, M25	C, CE	6 - 9
			CEP	4.5 - 8
6	F31, F32, F33, F34, F35	M31, M32, M33, M34, M35	C, CE	6 - 9
			CEP	4.5 - 8

Spindle and bushing details, chassis piercing: see p. 79 to 83.

Normalised spindles: see p. 84.



Carbon Rotary Potentiometers - 16 mm size

Ganged-Stereo

Plastic Case

Types
CIJP160KC
JP160KC

Mechanical data

Rotation angle:	270° ± 5°
Operating torque:	0.4 ÷ 1.8 Ncm
Permissible torque at end stop:	60 Ncm max
Permissible axial spindle load:	100 N (5 sec max)
Taps:	Z2 at 50% of rotation
Weight, std. spindle:	~ 7 g

Optional features

- Rotation angle 300° ± 5°:
types CIJP162KC and JP162KC
- Central click, for CIJP160KC and JP160KC only
- Earth terminations for metal case type

Electrical data

Rated dissipation @ 40°C:	2 x 0.25 W lin. law 2 x 0.12 W non-lin. law
Limiting element voltage:	350 VDC
Insulation resistance:	≥ 5 GΩ
Insulation voltage:	500 VAC
Rated resistance: E3 Series; optional E6 Series	
• linear law:	100R to 4M7
• non-linear law:	1K0 to 2M2
Tolerance on rated resistance:	
• 100R to 1M0:	± 20%
• over 1M0:	± 30%
• optional (1K0 to 1M0):	± 10%
Resistance law:	A, B, C, F, S, T, X
• with tap:	A2, B2, C2, S2
Matching tolerance:	class II; optional class I



H = 15 optional

Types

CIJP160KC	P.c. terminations
JP160KC	Solder tag terminations

Standard spindle & bush

D = 6 mm, L = 50 mm, plastic, F1 type
A = M10x0.75, CZ = 8 mm, KC type

Spindle and bushing variations

D = mm	Available types				
	Plastic spindle	Metal spindle	Bush	A = mm	CZ = mm
4	F21, F22, F23, F25	M21, M22, M23, M25	KZ	M7 x 0.75	5-8-12
			KC	M10 x 0.75	8
6	F31, F32, F33, F34, F35	M31, M32, M33, M34, M35	KZ	M7 x 0.75	5-8-12
	F1, F2, F3, F4, F5, F6 F10, F11, F12	M1, M2, M3, M4, M10, M11, M12	KZ	M10 x 0.75	5-8-12
			KC	M10 x 0.75	8

Spindle and bushing details, chassis piercing: see p. 79 to 83. - Normalised spindles: see p. 84.

These potentiometers are also available with metal case and bush (die-cast) as types CIJP160ZC and JP160ZC; bush CZ or ZKC type. All spindle variations and optional features are possible.

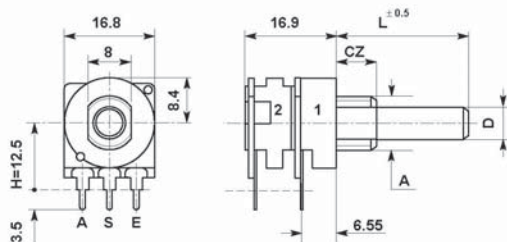

CIJP160KC

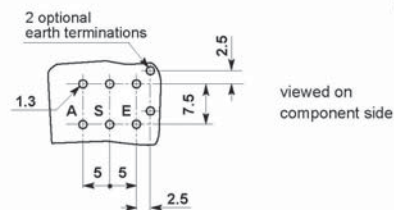



Carbon Rotary Potentiometers - 16 mm size

Ganged-multiples

Plastic Case

Types
CITJP160KC
TJP160KC
CIQJP160KC
QJP160KC

Mechanical data

Rotation angle: $270^\circ \pm 5^\circ$
Operating torque: 0.4 ± 1.8 Ncm
Permissible torque at end stop: 60 Ncm max
Permissible axial spindle load: 100 N
(5 sec max)
Taps: Z2 at 50% of rotation
Weight, std. spindle: triple ~ 10 g; quadr. ~ 13

Limiting element voltage: 350 VDC
Insulation resistance: ≥ 5 G Ω
Insulation voltage: 500 VAC
Rated resistance: E3 Series; optional E6 Series
• linear law: 100R to 4M7
• non-linear law: 1K0 to 2M2
Tolerance on rated resistance:
• 100R to 1M0: $\pm 20\%$
• over 1M0: $\pm 30\%$
• optional (1K0 to 1M0): $\pm 10\%$
Resistance law: A, B, C, F, S, T, X
• with tap: A2, B2, C2, S2

Electrical data

Rated dissipation @ 40°C:
3 or 4 x 0.25 W linear law
3 or 4 x 0.12 W non-linear law

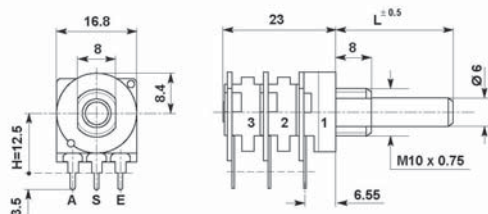

CITJP160KC

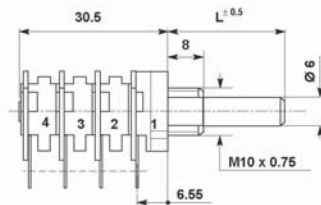

CIQJP160KC

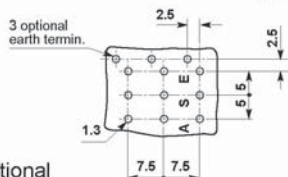

H = 15 optional

viewed on component side

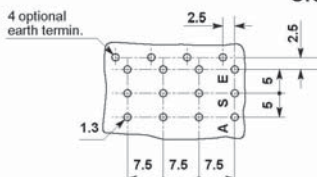

Types

Triple	Quadruple	Terminations
CITJP160KC	CIQJP160KC	Printed circ.
TJP160KC	QJP160KC	Solder tags

Standard spindle

L = 50 mm, plastic, F1 type

Optional features

- Central click
- Earth terminations for metal case types

Spindle variations

Plastic: F1 - F2 - F3 - F4 - F5 - F6 - F10 - F11 - F12

Metal: M1 - M2 - M3 - M4 - M10 - M11 - M12



Spindle details, chassis piercing: see p. 81-82. Normalised spindles: see p. 84.

These potentiometers are also available with metal case and bush (die-cast) as: triple types CITJP160ZC and TJP160ZC; quadruple types CIQJP160ZC and QJP160ZC; bush CZ or ZKC type. All spindle variations and optional features are possible.



Carbon Rotary Potentiometers - 16 mm size

Duals

Plastic Case

Types
CIDP160KC
DP160KC

Mechanical data

Rotation angle:	$270^\circ \pm 5^\circ$
Operating torque:	0.4 ± 1.8 Ncm
Permissible torque at end stop:	60 Ncm max
Permissible axial spindle load:	100 N (5 sec max)
Taps:	Z2 at 50% of rotation
Weight, std. spindle:	~ 15 g

External spindle D2 drives section 1
Internal spindle D1 drives section 2

Optional features

- Central click on the 1st section
- Section 1: 120° or 180° rotation with law S
- Earth terminations for metal case type

Electrical data

Rated dissipation @ 40°C :	2×0.25 W linear law 2×0.12 W non-linear law
Limiting element voltage:	350 VDC
Insulation resistance:	≥ 5 G Ω
Insulation voltage:	500 VAC
Rated resistance: E3 Series; optional E6 Series	
• linear law:	100R to 4M7
• non-linear law:	1K0 to 2M2
Tolerance on rated resistance:	
• 100R to 1M0:	$\pm 20\%$
• over 1M0:	$\pm 30\%$
• optional (1K0 to 1M0):	$\pm 10\%$
Resistance law:	A, B, C, F, S, T, X A2, B2, C2, S2
• with tap:	



H = 15 mm optional

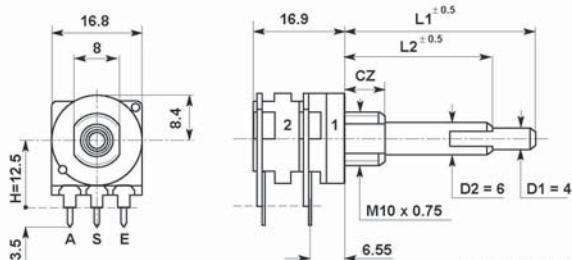

CIDP160KC

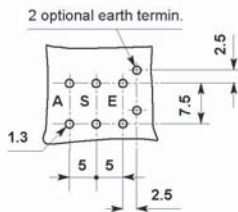

viewed on component side

Types

CIDP160KC	P.c. terminations
DP160KC	Solder tag terminations

Standard spindle & bush

L1 = 40 mm, L2 = 30 mm, metal, M15 type
CZ = 8 mm, KC type

Spindle and bushing details, chassis piercing: see p. 80 - 83.

These potentiometers are also available with metal case and bush (die-cast) as types CIDP160ZC and DP160ZC; bush CZ or ZKC type. All spindle variations and optional features are possible.



Carbon Rotary Potentiometers - 16 mm size

Duals-multiples

Die-cast Case

Types
CITDP160ZC
TDP160ZC
CIQDP160ZC
QDP160ZC

Mechanical data

Rotation angle: $270^\circ \pm 5^\circ$
Operating torque: 0.4 ± 1.8 Ncm
Permissible torque at end stop: 60 Ncm max
Permissible axial spindle load: 100 N
(5 sec max)

Weight, std. spindle: triple ~ 28 g
quadruple ~ 31 g

Triple types

External spindle D2 drives section 1
Internal spindle D1 drives sections 2 and 3

Optional features

- External spindle D2 drives sections 1 and 2
- Internal spindle D1 drives section 3
- Earth terminations

Electrical data

Rated dissipation @ 40°C :
3 or 4 x 0.25 W linear law
3 or 4 x 0.12 W non-linear law
Limiting element voltage: 350 VDC
Insulation resistance: ≥ 5 G Ω
Insulation voltage: 500 VAC
Rated resistance: E3 Series; optional E6 Series
• linear law: 100R to 4M7
• non-linear law: 1K0 to 2M2
Tolerance on rated resistance:
• 100R to 1M0: $\pm 20\%$
• over 1M0: $\pm 30\%$
• optional (1K0 to 1M0): $\pm 10\%$
Resistance law: A, B, C, F, S, T, X

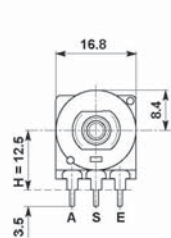

H = 15 optional

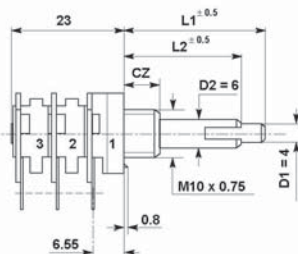

CITDP160ZC

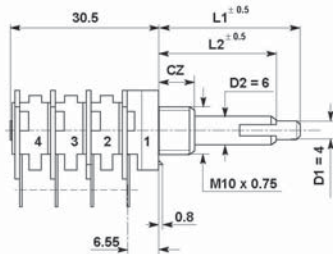

CIQDP160ZC

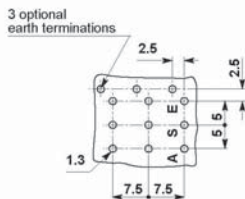

viewed on component side

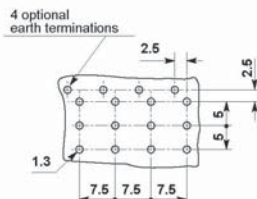

Quadruple types

External spindle D2 drives sections 1 and 2
Internal spindle D1 drives sections 3 and 4

Optional feature

- Earth terminations

Types

Triple	Quadruple	Terminations
CITDP160ZC	CIQDP160ZC	Printed circ.
TDP160ZC	QDP160ZC	Solder tags

Standard spindle & bush

L1 = 40 mm, L2 = 30 mm, metal, M15 type
CZ = 8 mm, CZ type

Spindle and bushing details, chassis piercing: see p. 80 - 83.



Carbon Rotary Potentiometers - 16 mm size

Singles with Rotary Switch

Types
CIP160C IL
P160C IL
CIP160C 2IL
P160C 2IL

Mechanical data

Rotation angle: $300^\circ \pm 5^\circ$
 Operating torque: 0.4 ± 1.5 Ncm
 Permissible torque at end stop: 35 Ncm max
 Permissible axial spindle load: 50 N
 (5 sec max)
 Tap: Z2 at 50% of rotation

Rotary switch:

Switching angle: $30^\circ \pm 5^\circ$
 Operating torque: 2 ± 5 Ncm
 Weight, std. spindle: ~ 9 g

Electrical data

Rated dissipation @ 40°C: 0.25 W linear law
 0.12 W non-linear law

Limiting element voltage: 350 VDC
 Insulation resistance: ≥ 5 G Ω
 Insulation voltage: 500 VAC
 Rated resistance: E3 Series; optional E6 Series
 • linear law: 100R to 4M7
 • non-linear law: 1K0 to 2M2
 Tolerance on rated resistance:
 • 100R to 1M0: $\pm 20\%$
 • over 1M0: $\pm 30\%$
 • optional (1K0 to 1M0): $\pm 10\%$
 Resistance law: A, B, C, F, T, S, X
 • with tap: A2, B2, C2, S2

Switch: 1-pole (SPST); 2-pole (DPST)
 Breaking capacity: 1.5-250 VAC resist. load
 5A-24 VDC

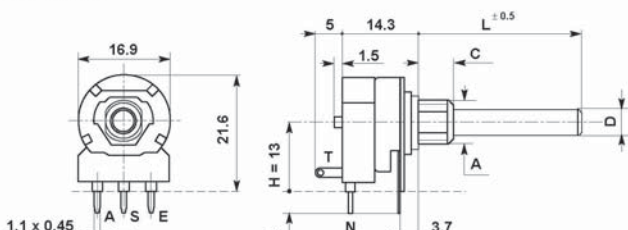
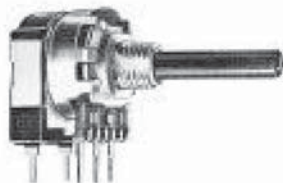

CIP160C 2IL

Standard spindle & bush

D = 4 mm; L = 32 mm, plastic, F21 type
 A = M7x0.75; C = 6 mm, C type

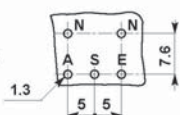

N 1-pole switch
 N & T 2-pole switch

viewed on component side

Types

CIP160C IL	1-pole switch - P.c. terminations
P160C IL	1-pole switch - Solder tag terminations
CIP160C 2IL	2-pole switch - P.c. terminations
P160C 2IL	2-pole switch - Solder tag terminations

Optional terminations
 • H = 15 mm
 • 9.3 mm length instead of 4 mm for H = 13 only

D mm	Available types				
	Plastic spindle	Metal spindle	Bush	C = mm	A = mm
4	F21, F22, F23, F25	M21, M22, M23, M25	C, CE	6 - 9	M7x0.75
			CEP	4.5 - 8	M7x0.75
6	F31, F32, F33, F34, F35	M31, M32, M33, M34, M35	C, CE	6 - 9	M7x0.75
			CEP	4.5 - 8	M7x0.75
	F1, F2, F3, F4, F5, F6, F10, F11, F12	NOT	KC	8	M10x0.75
			C9	6	M9x0.75

Spindle and bushing details, chassis piercing: see p. 79 to 83. Normalised spindles: see p. 84.



Carbon Rotary Potentiometers - 16 mm size

Singles with Rotary Switch

Plastic Case

Type
CIP160KC IP

Mechanical data

Rotation angle:	$300^\circ \pm 5^\circ$
Operating torque:	0.4 ± 1.5 Ncm
Permissible torque at end stop:	60 Ncm max
Permissible axial spindle load:	100 N (5 sec max)
Tap:	Z2 at 50% of rotation

Rotary switch:

Switching angle:	$30^\circ \pm 5^\circ$
Operating torque:	2.5 ± 6 Ncm
Weight, std. spindle:	~ 7 g

Optional features

- End rotation switch: circuit is open (OFF) at the start of clockwise rotation; closed (ON) at the end: CIP160KC IPFC type.
- Earth termination for metal case type.

Electrical data

Rated dissipation @ 40°C:	0.25 W linear law 0.12 W non-linear law
Limiting element voltage:	350 VDC
Insulation resistance:	≥ 5 G Ω
Insulation voltage:	500 VAC
Rated resistance: E3 Series; optional E6 Series	
• linear law:	100R to 4M7
• non-linear law:	1K0 to 2M2
Tolerance on rated resistance:	
• 100R to 1M0:	$\pm 20\%$
• over 1M0:	$\pm 30\%$
• optional (1K0 to 1M0):	$\pm 10\%$
Resistance law:	A, B, C, F, T, S, X
• with tap:	A2, B2, C2, S2
Switch:	1-pole (SPST)
Breaking capacity:	1-250 VAC resist.load 3A-24 VDC



H = 15 optional

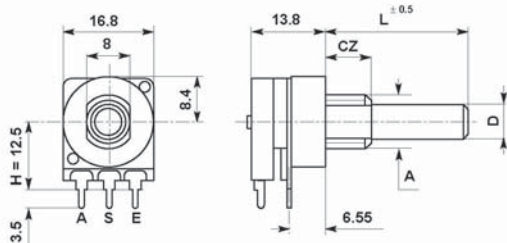

CIP160KC IP

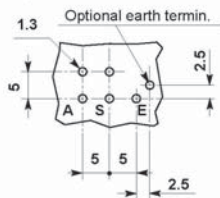

viewed on component side

Standard spindle & bush

D = 6 mm, L = 50 mm, plastic, F1 type
A = M10x0.75, CZ = 8 mm, KC type

Spindle and bushing variations

D mm	Available types				
	Plastic spindle	Metal spindle	Bush	A = mm	CZ = mm
4	F21, F22, F23, F25	M21, M22, M23, M25	KZ	M7 x 0.75	5-8-12
			KC	M10 x 0.75	8
6	F31, F32, F33, F34, F35	M31, M32, M33, M34, M35	KZ	M7 x 0.75	5-8-12
			KC	M10 x 0.75	8
	F1, F2, F3, F4, F5, F6, F10, F11, F12	M1, M2, M3, M4, M10, M11, M12	KZ	M10 x 0.75	5-8-12
			KC	M10 x 0.75	8

Spindle and bushing details, chassis piercing: see p. 79 to 83. Normalised spindles: see p. 84.

These potentiometers are also available with metal case and bush (die-cast) as types CIP160ZC IP; bush CZ or ZKC type. All spindle variations and optional features are possible.



Mechanical data

Rotation angle: $300^\circ \pm 5^\circ$
Operating torque: $0.4 \div 1.5$ Ncm
Permissible torque at end stop: 35 Ncm max
Permissible axial spindle load: 50 N
(5 sec max)

Rotary switch:

Switching angle: $30^\circ \pm 5^\circ$
Operating torque: $2 \div 5$ Ncm

Weight, std. spindle: ~ 5 g

Electrical data

Rated dissipation @ 40°C : 0.25 W linear law
0.12 W non-linear law

Limiting element voltage: 350 VDC

Insulation resistance: ≥ 5 G Ω

Insulation voltage: 500 VAC

Rated resistance: E3 Series; optional E6 Series

• linear law: 100R to 4M7

• non-linear law: 1K0 to 2M2

Tolerance on rated resistance:

• 100R to 1M0: $\pm 20\%$

• over 1M0: $\pm 30\%$

• optional (1K0 to 1M0): $\pm 10\%$

Resistance law: A, B, C, F, T, S, X

Switch: 1-pole (SPST)

Breaking capacity: 1A-250 VAC resist. load
3A-24 VDC

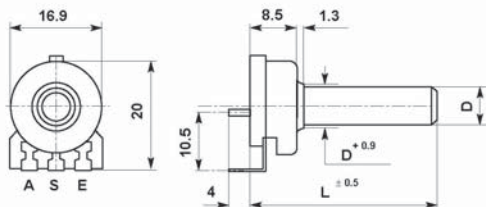
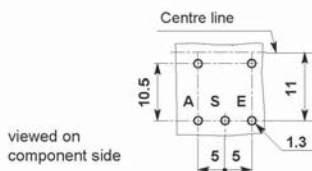

P160 IBA

Optional feature

Anti-clockwise switch: at the initial point of the clockwise rotation the switching circuit is closed (ON); the switch opens the circuit (OFF) at the end of the rotation angle.

Standard spindle

L = 50 mm, plastic, F1 type
D = 6 mm

Spindle minimum lengths

- F1 spindle type: L = 19 mm
- F5 - F6 spindle types: L = 17 mm
- Other spindle types: L = 8 mm more than their minimum lengths

Spindle variations

D = mm	Available types	
	Plastic spindle	Metal spindle
6	F1, F2, F3, F4, F5, F6, F10, F11, F12	NOT
4	F21, F22, F 23	NOT

Spindle details: see p. 81 to 83.

Normalised spindles: see p. 84



Mechanical data

Rotation angle: $300 \pm 5^\circ$
 Operating torque: $0.4 \div 1.5$ Ncm
 Permissible torque at end stop: 35 Ncm max
 Permissible axial spindle load: 50 N
 (5 sec max)
 Tap: Z2 at 50% of rotation

Rotary switch:

Switching angle: $30 \pm 5^\circ$
 Operating torque: $2 \div 5$ Ncm
 Weight, std. spindle: ~ 11 g

Electrical data

Rated dissipation @ 40°C : 0.25 W linear law
 0.12 W non-linear law
 Limiting element voltage: 350 VDC
 Insulation resistance: ≥ 5 G Ω
 Insulation voltage: 500 VAC
 Rated resistance: E3 Series; optional E6 Series
 • linear law: 100R to 4M7
 • non-linear law: 1K0 to 2M2
 Tolerance on rated resistance:
 • 100R to 1M0: $\pm 20\%$
 • over 1M0: $\pm 30\%$
 • optional: (1K0 to 1M0): $\pm 10\%$
 Resistance law: A, B, C, F, T, S, X
 • with tap: A2, B2, C2, S2

Switch: 1-pole (SPST); 2-pole (DPST)
 Breaking capacity: 1.5A-250 VAC resist. load
 5A-24 VDC

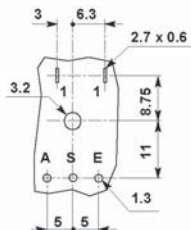
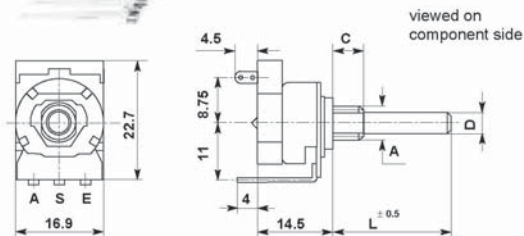

EP160C IL

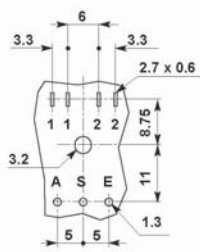

EP160C 2IL

Types

EP160C IL	1-pole switch
EP160C 2IL	2-pole switch

Standard spindle & bush

D = 4 mm; L = 32 mm, plastic, F21 type
 A = M7x0.75; C = 6 mm, C type

Spindle and bushing variations

D mm	Available types				
	Plastic spindle	Metal spindle	Bush	C = mm	A = mm
4	F21, F22, F23, F25	M21, M22, M23, M25	C, CE	6 - 9	M7x0.75
			CEP	4.5 - 8	M7x0.75
6	F31, F32, F33, F34, F35	M31, M32, M33, M34, M35	C, CE	6 - 9	M7x0.75
			CEP	4.5 - 8	M7x0.75
	F1, F2, F3, F4, F5, F6, F10, F11, F12	NOT	KC	8	M10x0.75
			C9	6	M9x0.75

Spindle and bushing details, chassis piercing: see p. 79 to 83. Normalised spindles: see p. 84.



Carbon Rotary Potentiometers - 16 mm size

Singles with Rotary Switch

Types
P161EC 1L
P161EC 2IL

Mechanical data

Rotation angle: $300^\circ \pm 5^\circ$
 Operating torque: $0.4 \div 1.5$ Ncm
 Permissible torque at end stop: 35 Ncm max
 Permissible axial spindle load: 50 N
 (5 sec max)
 Tap: Z2 at 50% of rotation

Rotary switch:

Switching angle: $30^\circ \pm 5^\circ$
 Operating torque: $2 \div 5$ Ncm

Weight, std. spindle: ~ 11 g

Electrical data

Rated dissipation @ 40°C: 0.25 W linear law
 0.12 W non-linear law

Limiting element voltage: 350 VDC
 Insulation resistance: ≥ 5 GΩ
 Insulation voltage: 500 VAC
 Rated resistance: E3 Series; optional E6 Series
 • linear law: 100R to 4M7
 • non-linear law: 1K0 to 2M2

Tolerance on rated resistance:
 • 100R to 1M0: $\pm 20\%$
 • over 1M0: $\pm 30\%$
 • optional (1K0 to 1M0): $\pm 10\%$

Resistance law: A, B, C, F, T, S, X
 • with tap: A2, B2, C2, S2

Switch: 1-pole (SPST); 2-pole (DPST)

Breaking capacity: 1.5A-250 VAC resist. load
 5A - 24 VDC

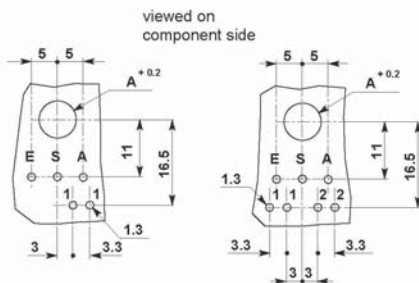
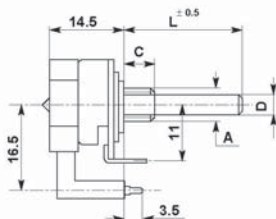
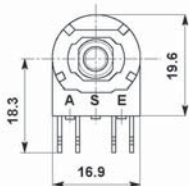

P161EC 1L

P161EC 2IL

Types

P161EC 1L	1-pole switch
P161EC 2IL	2-pole switch

Standard spindle & bush

D = 4 mm; L = 32 mm, plastic, F21 type
 A = M7x0.75; C = 6 mm, C type

Spindle and bushing variations

D mm	Available types				
	Plastic spindle	Metal spindle	Bush	C = mm	A = mm
4	F21, F22, F23, F25	M21, M22, M23, M25	C, CE	6 - 9	M7x0.75
			CEP	4.5 - 8	M7x0.75
6	F31, F32, F33, F34, F35	M31, M32, M33, M34, M35	C, CE	6 - 9	M7x0.75
			CEP	4.5 - 8	M7x0.75
	F1, F2, F3, F4, F5, F6, F10, F11, F12	NOT	KC	8	M10x0.75
			C9	6	M9x0.75

Spindles and bushing details, chassis piercing: see p. 79 to 83. Normalised spindles: see p. 84.



Mechanical data

Rotation angle:	$270^\circ \pm 5^\circ$
Operating torque:	$0.5 + 2 \text{ Ncm}$
Permissible torque at end stop	
• plastic spindle:	35 Ncm max
• metal spindle:	80 Ncm max
Permissible axial spindle load:	100 N (5 sec max)

Push-push switch:

Operating total travel:	3.5 mm max
Operating force:	20 N max

Inserted by pressing the spindle (ON), it comes back to the rest position when released; switching OFF by pressing again.

Weight, std. spindle: ~ 11 g

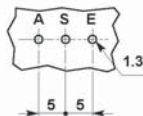
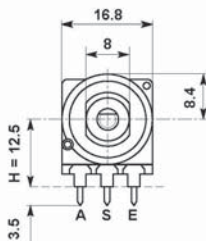
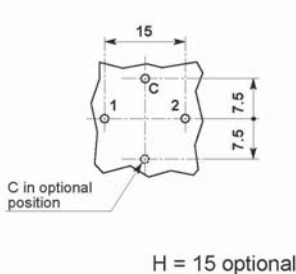

Electrical data

Rated dissipation @ 40°C: 0.25 W linear law
0.12 W non-linear law

Limiting element voltage:	350 VDC
Insulation resistance:	$\geq 5 \text{ G}\Omega$
Insulation voltage:	500 VAC
Rated resistance: E3 Series; optional E6 Series	
• linear law:	100R to 4M7
• non-linear law:	1K0 to 2M2

Tolerance on rated resistance:

• 100R to 1M0:	$\pm 20\%$
• over 1M0:	$\pm 30\%$
• optional (1K0 to 1M0):	$\pm 10\%$

Resistance law: A, B, C, F, S, X

Switch

Breaking capacity: 10A - 250 VAC resist. load
Temperature: T100

Approval: VDE 0630/06.92

Depending on electrical connections, it may be used as:

- Single-pole switch (SPST) or
- Single-pole commutator (SPDT)

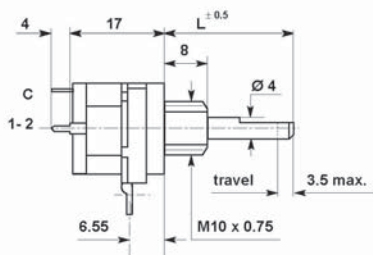

CIP160KC IPP

viewed on component side

Standard spindle

D = 4 mm, L = 20.5 mm, plastic F22 type

Spindle variations

Plastic F21 - F23

Metal M21 - M22 - M23

Spindle details, chassis piercing: see p. 83

Normalised spindles: see p. 84.





Carbon Rotary Potentiometers - 16 mm size

Singles with Push-push Switch
Plastic Case

Type
EP160KC IPP

Mechanical data

Rotation angle:	270° ± 5°
Operating torque:	0.5 ± 2 Ncm
Permissible torque at end stop	
• plastic spindle:	35 Ncm max
• metal spindle:	80 Ncm max
Permissible axial spindle load:	100 N (5 sec max)

Push-push switch:

Operating total travel:	3.5 mm max
Operating force:	20 N max

Inserted by pressing the spindle (ON), it comes back to the rest position when released; switching OFF by pressing again.

Weight, std. spindle: ~ 11 g



Electrical data

Rated dissipation @ 40°C:	0.25 W linear law 0.12 W non-linear law
Limiting element voltage:	350 VDC
Insulation resistance:	≥ 5 GΩ
Insulation voltage:	500 VAC
Rated resistance: E3 Series; optional E6 Series	
• linear law:	100R to 4M7
• non-linear law:	1K0 to 2M2
Tolerance on rated resistance:	
• 100R to 1M0:	± 20%
• over 1M0:	± 30%
• optional (1K0 to 1M0):	± 10%
Resistance law:	A, B, C, F, S, X

Switch

Breaking capacity: 10A - 250 VAC resist. load
Temperature: T100

Approval: VDE 0630/06.92

Depending on electrical connections, it may be used as:

- Single-pole switch (SPST) or
- Single-pole commutator (SPDT)

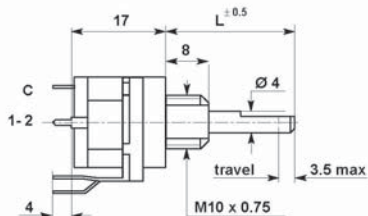
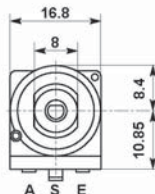
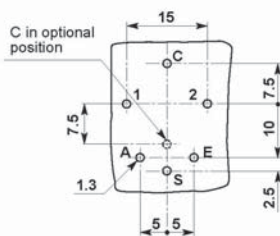

EP160KC IPP

Standard spindle

D = 4 mm, L = 20.5 mm, plastic F22 type

Spindle variations

Plastic F21 - F22 - F23
Metal M21 - M22 - M23

Spindle details, chassis piercing: see p. 83
Normalised spindles: see p. 84.





Carbon Rotary Potentiometers - 16 mm size

Singles with Push-push Switch
Plastic Case

Type
EP165 IPP

Mechanical data

Rotation angle: $270^\circ \pm 5^\circ$
 Operating torque: $0.5 + 2$ Ncm
 Permissible torque at end stop: 40 Ncm max
 Permissible axial spindle load: 100 N
 (5 sec max)

Push-push switch:

Operating total travel: 4 mm max
 Operating force: 20 N max

Inserted by pressing the spindle (ON), it comes back to the rest position when released; switching OFF by pressing again.

Weight: ~ 9 g

Electrical data

Rated dissipation @ 40°C: 0.25 W linear law
 0.12 W non-linear law

Limiting element voltage: 350 VDC

Insulation resistance: ≥ 5 GΩ

Insulation voltage: 500 VAC

Rated resistance: E3 Series; optional E6 Series

• linear law: 100R to 4M7

• non-linear law: 1K0 to 2M2

Tolerance on rated resistance:

• 100R to 1M0: $\pm 20\%$

• over 1M0: $\pm 30\%$

• optional (1K0 to 1M0): $\pm 10\%$

Resistance law: A, B, C, F, S, X

Switch

Breaking capacity: 10A - 250 VAC resist. load

Temperature: T100

Approval: VDE 0630/06.92

Depending on electrical connections, it may be used as:

- Single-pole switch (SPST) or
- Single-pole commutator (SPDT)

NEW

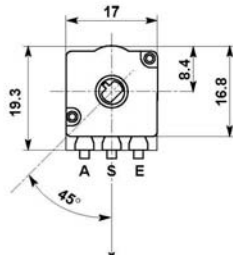
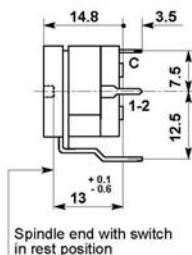
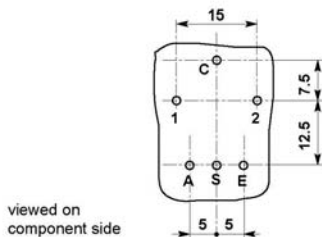

EP165 IPP

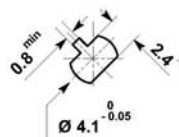

In full anti-clockwise position

Spindle EP 165 Plastic

available on request

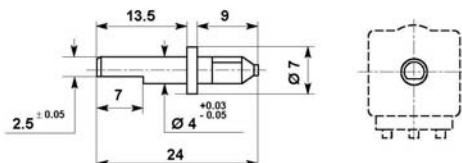

Spindle in full anti-clockwise position





Carbon Rotary Potentiometers - 16 mm size

Click-stops

Die-cast and Plastic Case

Types
CIR1P160ZC
CIR11P160ZC
CIR31P160ZC
CIR41P160ZC

Mechanical Data

Rotation angle:	270° ± 5°
Operating torque:	1 + 3 Ncm
• CIR31P160ZC only:	4 + 6 Ncm
Permissible torque at end stop:	60 Ncm max
Permissible axial spindle load:	100 N (5 sec max)
Tap:	Z2 at 50% of rotation
Weight, std. spindle:	~ 19 g

Optional feature

- Earth termination

Electrical data

Rated dissipation @ 40°C:	0,25 W linear law 0,12 W non-linear law
Limiting element voltage:	350 VDC
Insulation resistance:	≥ 5 GΩ
Insulation voltage:	500 VAC
Rated resistance: E3 Series; optional E6 Series	
• linear law:	100R to 4M7
• non-linear law:	1K0 to 2M2
Tolerance on rated resistance:	
• 100R to 1M0:	± 20%
• over 1M0:	± 30%
• optional (1K0 to 1M0):	± 10%
Resistance law:	A, B, C, F, T, S, X
• with tap:	A2, B2, C2, S2

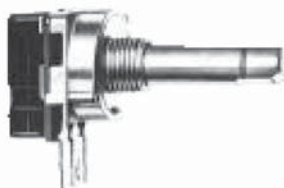

Types

CIR1P160ZC	1 click-stop
CIR11P160ZC	11 click-stops
CIR31P160ZC	31 click-stops
CIR41P160ZC	41 click-stops

Standard spindle & bush

D = 6mm, L = 50 mm, plastic, F1 type
A = M10x0.75, CZ = 8 mm, CZ type.

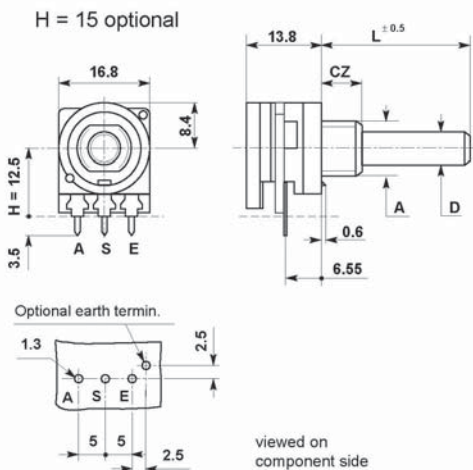

Spindle and bushing variations

D = mm	Available types				
	Plastic spindle	Metal spindle	Bush	A = mm	CZ = mm
4	F21, F22, F23, F25	M21, M22, M23, M25	CZ	M7 x 0.75	5-8-12
6	F31, F32, F33, F34, F35	M31, M32, M33, M34, M35	CZ	M7 x 0.75	5-8-12
	F1, F2, F3, F4, F5, F6, F10, F11, F12	M1, M2, M3, M4, M10, M11, M12	CZ	M10 x 0.75	5-8-12
			ZKC	M10 x 0.75	8

Spindle and bushing details, chassis piercing: see p. 80 to 83.



Carbon Rotary Potentiometers - 16 mm size

Dust-proof

Plastic Case

Types
CIP160TZC
P160TZC

Mechanical data

Rotation angle:	270° ± 5°
Operating torque:	0.4 + 1.5 Ncm
Permissible torque at end stop:	60 Ncm max
Permissible axial spindle load:	100 N (5 sec max)
Life:	≥ 15.000 cycles
Weight, std spindle:	~ 13 g

Optional feature

- Rotation angle 300° ± 5°:
Types CIP162TZC and P162TZC.

Resin compounding-proof

These potentiometers - except the bush and spindle - can be dipped into the usual insulating resin compounding.

Electrical data

Rated dissipation @ 40°C:	0.25 W linear law 0.12 W non-linear law
Limiting element voltage:	350 VDC
Insulation resistance:	≥ 5 GΩ
Insulation voltage:	500 VAC
Rated resistance: E3 Series; optional E6 Series	
• linear law:	100R to 4M7
• non-linear law:	1K0 to 2M2
Tolerance on rated resistance:	
• 100R to 1M0:	± 20%
• over 1M0:	± 30%
• optional (1K0 to 1M0):	± 10%
Resistance law:	A, B, C, F, S, T, X

NEW

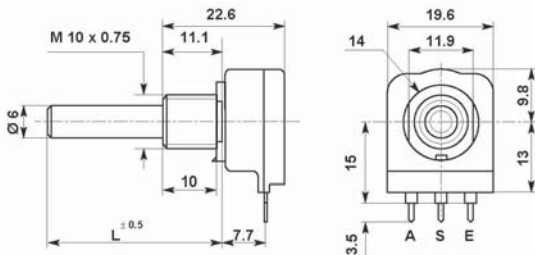

CIP16TZC

viewed on component side

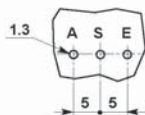

Types

CIP160TZC	P.c. terminations
P160TZC	Solder tag terminations

Standard spindle

L = 50 mm, plastic, F1 type

Spindle variations

Available types	
Plastic spindle	Metal spindle
F1, F2, F3, F4, F5, F6, F10, F11, F12	M1, M2, M3, M4, M 10, M11, M12

Chassis piercing
2 possibilities

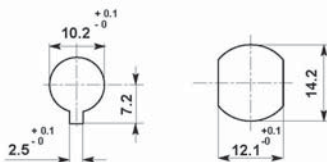

Spindle details: see p. 81 - 82.

Normalised spindles: see p. 84.



Mechanical data

Rotation angle: $270^\circ \pm 5^\circ$
 Operating torque: $0.4 \div 1.5$ Ncm
 Permissible torque at end stop: 35 Ncm max
 Weight, std. spindle: ~ 4 g

Optional features:

- Rotation angle $300^\circ \pm 5^\circ$: type P162 BM

Electrical data

Rated dissipation @ 40°C : 0.25 W linear law
 0.12 W non-linear law
 Limiting element voltage: 350 VDC
 Insulation resistance: ≥ 5 G Ω
 Insulation voltage: 500 VAC
 Rated resistance: E3 Series; optional E6 Series
 • linear law: 100R to 4M7
 • non-linear law: 1K0 to 2M2
 Tolerance on rated resistance:
 • 100R to 1M0: $\pm 20\%$
 • over 1M0: $\pm 30\%$
 • optional (1K0 to 1M0): $\pm 10\%$
 Resistance law: A, B, C, F, T, S, X

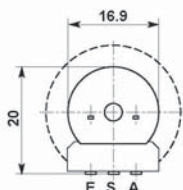

P160 BM

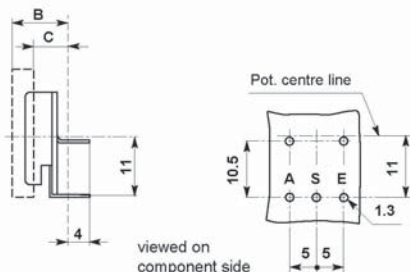

Potentiometers are supplied without knob.

Knobs are supplied on request, not mounted.

knob type	B = mm	C = mm
D22	10.4	6.4
D24	10.2	8.2
D30	10.2	4.2
D 30 A	14.8	8.6
D40	10.8	4

Plastic knobs

Colour: grey

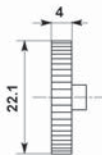

D22

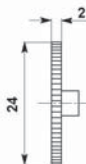

D24

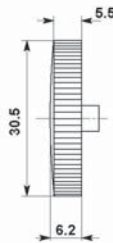

D30
D30 A

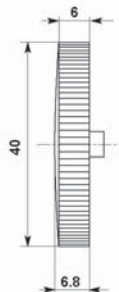

D40



Mechanical data

Rotation angle: $300^\circ \pm 5^\circ$
Operating torque: 0.4 ± 1.5 Ncm
Permissible torque at end stop: 35 Ncm max

Switch

Switching angle: $30^\circ \pm 5^\circ$
Operating torque: 2 ± 5 Ncm
Weight: ~ 4 g

Optional feature

Anti-clockwise switch: at the initial point of the clockwise rotation the switching circuit is closed (ON); the switch opens the circuit (OFF) at the end of the rotation angle.

Electrical data

Rated dissipation @ 40°C : 0.25 W linear law
0.12 W non-linear law
Limiting element voltage: 350 VDC
Insulation resistance: ≥ 5 G Ω
Insulation voltage: 500 VAC
Rated resistance: E3 Series; optional E6 Series
• linear law: 100R to 4M7
• non-linear law: 1K0 to 2M2
Tolerance on rated resistance:
• 100R to 1M0: $\pm 20\%$
• over 1M0: $\pm 30\%$
• optional (1K0 to 1M0): $\pm 10\%$
Resistance law: A, B, C, F, S, T, X

Switch: 1-pole (SPST)
Breaking capacity: 1A - 250 VAC resist. load
3A - 24 VDC

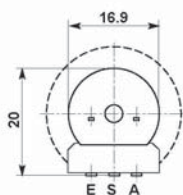

P160 IBM

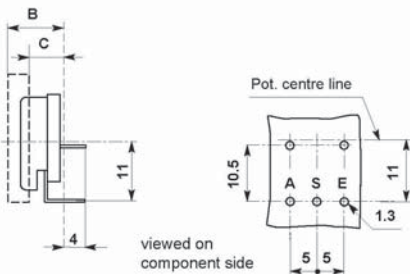

Potentiometers are supplied without knob.

Knobs are supplied on request, not mounted.

knob type	B = mm	C = mm
D22	10.4	6.4
D24	10.2	8.2
D30	10.2	4.2
D 30 A	14.8	8.6
D40	10.8	4

Plastic knobs

Colour: grey

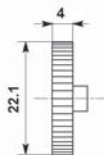

D22

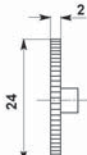

D24

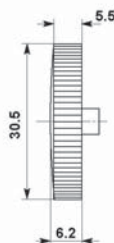

D30
D30 A

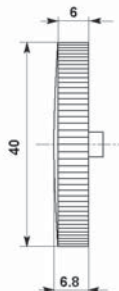

D40



Mounting Bushes - M7

Type		Chassis piercing	C - CZ			
			std.	option.		
C	Metal				6	9
CE	Metal				6	9
CEP	Metal				4.5	8
CZ	Metal				5	8 12
KZ	Plastic					

Available bushes are specified on the pages describing each potentiometer type.

Potentiometers with bush are supplied with a nut, not mounted.



Mounting Bushes - M10 & M9

Type		Chassis piercing	CZ			
			std.	option.		
CZ	Metal				8	5 12
KZ	Plastic					
ZKC	Metal					
KC	Plastic					
C9	Plastic					

Available bushes are specified on the pages describing each potentiometer type.

Potentiometers with bush are supplied with a nut, not mounted.



Carbon Rotary Potentiometers - 16 mm size





Spindle variations - 6 mm diameter	Available types	
	Plastic	Metal
<p>$D = 6$ $L \pm 0.5$</p> <p>L = 15 to 60</p>	F1	M1
<p>$D = 6$ $L \pm 0.5$</p> <p>L = 15 to 60</p> <p>spindle in full CCW position</p> <p>205° Optional 210° Optional 225°</p> <p>standard</p>	F2	M2
<p>$D = 6$ $L \pm 0.5$</p> <p>A = 15 - L = 20 to 60 A = 10 - L = 15 to 60</p> <p>spindle in full CCW position</p> <p>205° Optional 210° Optional 225°</p> <p>standard</p>	F3 A = 15	M3 A = 15
	F4 A = 10	M4 A = 10
<p>$D = 6$ $L \pm 0.5$</p> <p>A = 10 - L = 15 to 60 A = 15 - L = 20 to 60 A = 20 - L = 25 to 60</p> <p>spindle in full CCW position</p> <p>205°</p>	F10 A = 10	M10 A = 10
	F11 A = 15	M11 A = 15
	F12 A = 20	M12 A = 20

The orientation of the flat indicated in the drawings is for plastic spindles only. The optional orientations of 210° and 225° place the flat in horizontal position (zero degrees) at half of rotation angle, respectively in potentiometers with 300° and 270° of rotation angle.

For metal spindles, unless specified in the order, the orientation of the flat may change in each potentiometer.

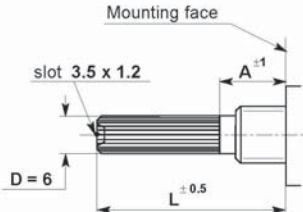
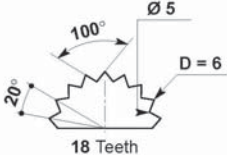
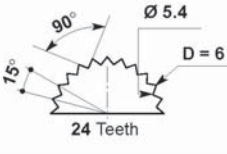
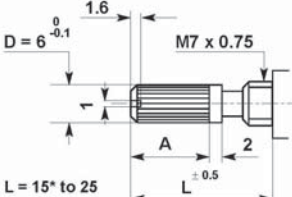
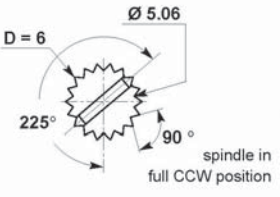
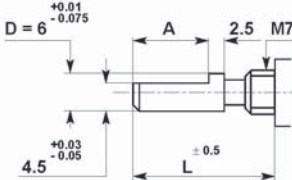

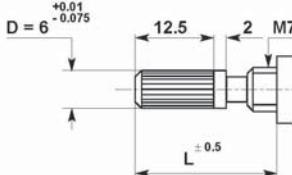
Carbon Rotary Potentiometers - 16 mm size

Spindle variations - 6 mm diameter		Available types	
		Plastic	Metal
 <p>$D = 6$</p> <p>slot 3.5 x 1.2</p> <p>Mounting face</p> <p>$A \pm 1$</p> <p>$L \pm 0.5$</p>	 <p>100°</p> <p>$\varnothing 5$</p> <p>$D = 6$</p> <p>20°</p> <p>18 Teeth</p>	F5 18 teeth	NOT
	 <p>90°</p> <p>$\varnothing 5.4$</p> <p>$D = 6$</p> <p>15°</p> <p>24 Teeth</p>	F6 24 teeth	NOT
<p>A = 10 or 6 L = 10 to 60</p>			
 <p>18 teeth</p> <p>$D = 6$</p> <p>1.6</p> <p>M7 x 0.75</p> <p>A</p> <p>2</p> <p>$L \pm 0.5$</p> <p>A = 7,5 L = 15* to 25 A = 12,5 L = 20* to 30</p>	 <p>$\varnothing 5.06$</p> <p>$D = 6$</p> <p>225°</p> <p>90°</p> <p>spindle in full CCW position</p> <p>210° for P162 types</p>	F31 A = 7.5	M31 A = 7.5
			F32 A = 12.5
 <p>$D = 6$</p> <p>A</p> <p>2.5</p> <p>M7 x 0.75</p> <p>$L \pm 0.5$</p> <p>A = 7 L = 15* to 25 A = 12 L = 20* to 30</p>	 <p>225°</p> <p>spindle in full CCW position</p> <p>210° for P162 types</p>	F33 A = 7	M33 A = 7
			F34 A = 12
 <p>40 teeth</p> <p>$D = 6$</p> <p>12.5</p> <p>2</p> <p>M7 x 0.75</p> <p>$L \pm 0.5$</p> <p>L = 20* to 30</p>	 <p>Index</p> <p>spindle in full CCW position</p> <p>45°</p> <p>30° for P162 types</p>	F35	M35

* Bush lengths: 4,5 mm or 5 mm.

Available spindles are specified on the pages describing each potentiometer type.



Carbon Rotary Potentiometers - 16 mm size

Spindle variations - 4 mm diameter	Available types	
	Plastic	Metal
<p>$D = 4^{+0.03}_{-0.05}$</p> <p>$L \pm 0.5$</p> <p>$L = 8 \text{ to } 60$</p>	F21	M21
<p>$D = 4^{+0.03}_{-0.05}$</p> <p>A</p> <p>$L \pm 0.5$</p> <p>3 ± 0.05</p> <p>spindle in full CCW position</p> <p>standard optional</p> <p>90°</p>	F22 $A = 8.5$	M22 $A = 8.5$
	F23 $A = 13.5$	M23 $A = 13.5$
<p>$D = 4^{+0.03}_{-0.05}$</p> <p>6</p> <p>1.5</p> <p>1</p> <p>10</p> <p>$M7 \times 0.75$</p> <p>$L \pm 0.5$</p> <p>spindle in full CCW position</p> <p>225°</p>	F25	M25
Separate Concentric Spindle	Type	
<p>$D2 = 6^{+0.01}_{-0.05}$</p> <p>$D1 = 4^{+0.01}_{-0.05}$</p> <p>6.5</p> <p>$L2 \pm 0.5$</p> <p>$L1 \pm 0.5$</p> <p>slot position undetermined</p> <p>2.5</p> <p>$L1 = 60 \text{ max}$</p> <p>$L2 = 50 \text{ max}$</p>	M15 Metal	

The orientation of the flat indicated in the drawings is for plastic spindles only. For metal spindles, unless specified in the order, the orientation of the flat may change in each potentiometer.

Available spindles are specified on the pages describing each potentiometer type.



Carbon Rotary Potentiometers - 16 mm size

Normalised plastic spindles

Standard types & lengths

Potentiometer types	D mm	Spindle types	Normalised lengths - mm										
			15	18	20	22	25	30	32	40	60		
(CI) P160C	4	F21 - F22-F23	15	18	20	22	25	30	32	40	60		
CI P161C	6	F31-F32-F33-F34-F35-F1-F6	⁽²⁾ 15	20	25	30							
P160BA	6	F1 - F3-F6	⁽¹⁾ 20	22	25	30	40	50					
(CI) JP16C	4	F21 - F22-F23	15	18	20	22	25	30	32	40	60		
	6	F31-F32-F33-F34-F35-F1-F6	⁽²⁾ 15	20	25	30							
(CI) PC160C IL/2IL EP160C IL/2IL P161EC IL/2IL	4	F21 - F22-F23	15	18	20	22	25	30	32	40	60		
	6	F31-F32-F33-F34-F35-F1-F6	⁽²⁾ 15	20	25	30							
P160 IBA	6	F1 - F3-F6	⁽¹⁾ 20	22	25	30	40	50					
(CI) P160KC	4	F21-F22-F23	15	18	20	22	25	30	40				
	6	F1 -F6	15	18	20	22	25	30	40	50	60		
EP160Z-EPP160Z	6	F1 -F6	21	26	29	31	33	36	41	51	61		
EP160KC EPP160KC P160EKC	6	F1 -F6	10	15	18	20	22	25	30	40	50	60	
P160ZCS	4	F21-F22-F23	15	18	20	22	25	30	40				
	6	F1 -F6	15	18	20	22	25	30	40	50	60		
SP160Z	6	F1 -F6	21.5	24.5	26.5	28.5	31.5	36.5	46.5	50			
EP160KC IPP CI P160KC IPP	4	F21- F22 -F23	15	18.5	20.5	22	25	30	40				
CI P160KC IP (CI) JP160KC	4	F21-F22-F23	15	18	20	22	25	30	40				
	6	F1 -F6	15	18	20	22	25	30	40	50	60		
(CI) TJP160KC (CI) QJP160KC	6	F1 -F6	10	15	18	20	22	25	30	35	50	60	
(CI) P160TZC	6	F1 -F6	16	19	21	23	26	31	41	50			

(1) F6 type only

(2) F31 and F33 types only

F22-F23 types: with flat in standard position

Normalised metal spindles

(CI) P160C	4	M21	13	15	17	20	25					
(CI) JP16C	4	M22 flat 90°	13	15	17							
(CI) P160KC	4	M22 flat 225°	13	15	17	20	25					
(CI) JP160KC	4	M23 flat 90°	18	20	22	25	30					
(CI) P160C IL/2IL	6	M31-M33	15	17								
(CI) P160KC IP	6	M32-M34-M35	20	22	25	30						



Carbon Rotary Potentiometers - 16 mm size

Mechanical position of the taps

Tap	Nominal Rotation %	(1) Types P160 & JP16C	Types P160KC & P160ZC	
Z2	50%			

(1) Tap termination is the same both for P.c. and solder potentiometers.
Obtainable tap is specified on the pages describing each potentiometer type.

Mounting accessories

Bushes M7			
Bushes M9			
Bushes M10			

Potentiometers with bush are supplied with a nut, not mounted.
The toothed lockwasher is supplied on request only, not mounted.



How to order

Désignation pour passer une commande

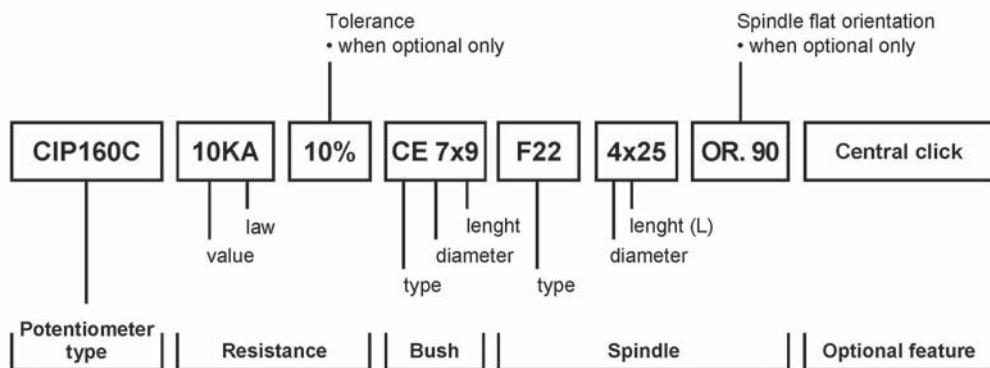

- Resistance laws: see p. 29 to 34.
- Bushes: see p. 79 - 80.
- Spindles: see p. 81 to 83.

Available resistance values, resistance laws, optional tolerance, spindle types and optional features are specified on the pages describing each potentiometer type.



Singles

Singles with Socket

Ganged-stereo

Duals

Simples

Simples avec étrier

Jumelés stéréo

Doubles

With Rotary Switch

With Rotary Switch and Socket

Avec interrupteur rotatif

Avec interrupteur rotatif et étrier

Edge Control Potentiometers

Potentiomètres à molette

Mounting bushes

Spindle variations

Normalised spindles

Position of the taps

Mounting accessories

Canons de montage

Variations de l'axe

Axes normalisés

Position des prises

Ecrous et rondelles

How to order

Désignation pour passer une commande



Mechanical data

Rotation angle:	$300^\circ \pm 5^\circ$
Operating torque:	0.4 ± 1.5 Ncm
Permissible torque at end stop:	80 Ncm max
Permissible axial spindle load:	100 N (5 sec max)
Tap:	Z2 at 50% or 57% of rotation
Weight, std. spindle:	~ 11 g

Electrical data

Rated dissipation @ 40°C:	0.4 W linear law 0.2 W non-linear law
Limiting element voltage:	500 VDC
Insulation resistance:	≥ 5 G Ω
Insulation voltage:	1000 VAC
Rated resistance: E3 Series; optional E6 Series	
• linear law:	100R to 4M7
• non-linear law:	1K0 to 2M2
Tolerance on rated resistance:	
• 100R to 1M0:	$\pm 20\%$
• over 1M0:	$\pm 30\%$
• optional (1K0 to 1M0):	$\pm 10\%$
Resistance law:	A, B, C, F, S, T, X
• with tap:	A2, B2, S2



Types

CIP20C	P.c. terminations
P20C	Solder tag terminations

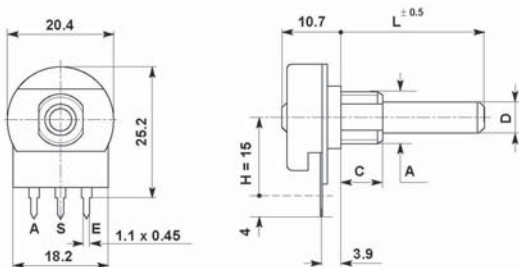

Standard spindle & bush

L = 50 mm, plastic, F1 type
D = 6 mm
A = M10x0.75, plastic, KC type
C = 8 mm

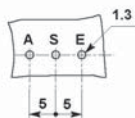

viewed on
component side

H = 22 optional

CIP20C

Spindle and bushing variations

D mm	A mm	Available types		
		Bush	Plastic Spindle	Metal Spindle
6	M10x0.75	KC, C, CE, CEBS	Fixed Plug-in	Fixed
4	M10x0.75 M7x0.75	C, CE C, CE	Fixed	Fixed

Spindle and bushing details, chassis piercing: see p. 108 to 111.

Normalised spindles: see p. 112.



Carbon Rotary Potentiometers - 20 mm size

Singles

Types
CIP20PD
P20EPD
P20PD

Mechanical data

Rotation angle:	$300^\circ \pm 5^\circ$
Operating torque:	$0.4 \div 1.5$ Ncm
Permissible torque at end stop:	80 Ncm max
Permissible axial spindle load:	100 N (5 sec max)
Tap:	Z2 at 50% or 57% of rotation
Weight, std. spindle:	~ 10 g

Electrical data

Rated dissipation @ 40°C:	0.4 W linear law 0.2 W non-linear law
Limiting element voltage:	500 VDC
Insulation resistance:	≥ 5 G Ω
Insulation voltage:	1000 VAC
Rated resistance: E3 Series; optional E6 Series	
• linear law:	100R to 4M7
• non-linear law:	1K0 to 2M2
Tolerance on rated resistance:	
• 100R to 1M0:	$\pm 20\%$
• over 1M0:	$\pm 30\%$
• optional (1K0 to 1M0):	$\pm 10\%$
Resistance law:	A, B, C, F, S, T, X, A2, B2, S2
• with tap:	

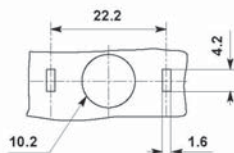
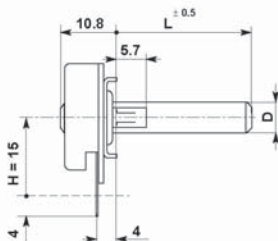
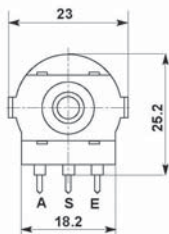

chassis piercing

CIP20PD

Standard spindle

L = 50 mm, plastic,
F1 type
D = 6 mm

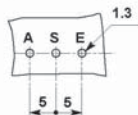

H = 22 optional

viewed on
component side

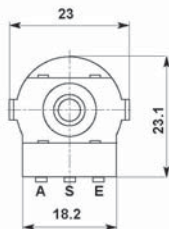

P20EPD

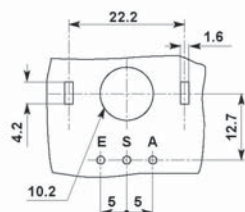
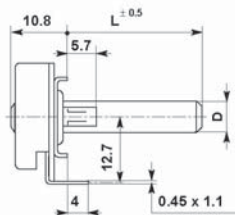

Types

CIP20PD	P.c. terminations
P20PD	Solder tag terminations
P20EPD	P.c. terminations

Spindle details: see p. 109 to 111

Normalised spindles: see p. 112

Spindle variations

D mm	Available types	
	Plastic Spindle	Metal Spindle
6	Fixed Plug-in	Fixed
4	Fixed	Fixed



Mechanical data

Rotation angle: $300^\circ \pm 5^\circ$
 Operating torque: $0.4 \div 1.5$ Ncm
 Permissible torque at end stop: 35 Ncm max
 Permissible axial spindle load: 100 N
 (5 sec max)
 Weight, std. spindle: ~ 10 g

Electrical data

Rated dissipation @ 40°C : 0.4 W linear law
 0.2 W non-linear law
 Limiting element voltage: 500 VDC
 Insulation resistance: ≥ 5 G Ω
 Insulation voltage: 1000 VAC
 Rated resistance: E3 Series; optional E6 Series
 • linear law: 100R to 4M7
 • non-linear law: 1K0 to 2M2
 Tolerance on rated resistance:
 • 100R to 1M0: $\pm 20\%$
 • over 1M0: $\pm 30\%$
 • optional (1K0 to 1M0): $\pm 10\%$
 Resistance law: A, B, C, F, T, S, X

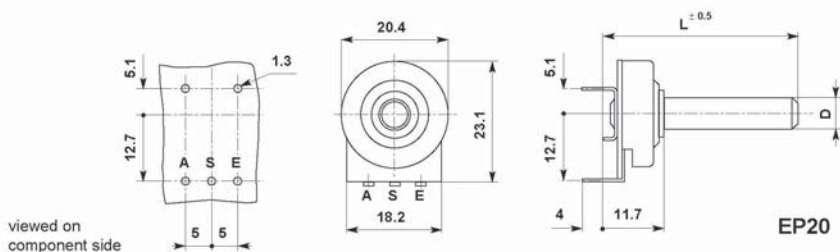

Standard spindle

L = 50 mm, plastic, F1 type
 D = 6 mm

Spindle minimum lengths

L = mm	Plastic fixed spindle types
20	F1 - F5 - F6 - F21
24	F10 - F22
27	F2 - F4 - F23
30	F3 - F11
34	F12

Spindle variations

D mm	Available types	
	Plastic Spindle	Metal Spindle
6	Fixed Plug-in Removable*	Not
4	Fixed Removable*	Not



Standard flat orientation
plastic spindle
in full CCW position

* **Removable spindle:** it can be put in and out of the potentiometer, holding strength > 1 Kg. Available spindle types are the same as fixed spindles. The removable spindle is supplied not mounted.

Spindle details: see p. 109 to 111. Normalised spindles: see p.112



Mechanical data

Rotation angle: $300^\circ \pm 5^\circ$
 Operating torque: 0.4 ± 1.5 Ncm
 Permissible torque at end stop: 80 Ncm max
 Permissible axial spindle load: 100 N
 (5 sec max)
 Weight, std. spindle: ~ 11 g

Electrical data

Rated dissipation @ 40°C: 0.4 W linear law
 0.2 W non-linear law
 Limiting element voltage: 500 VDC
 Insulation resistance: ≥ 5 G Ω
 Insulation voltage: 1000 VAC
 Rated resistance: E3 Series; optional E6 Series
 • linear law: 100R to 4M7
 • non-linear law: 1K0 to 2M2
 Tolerance on rated resistance:
 • 100R to 1M0: $\pm 20\%$
 • over 1M0: $\pm 30\%$
 • optional (1K0 to 1M0): $\pm 10\%$
 Resistance law: A, B, C, F, T, S, X

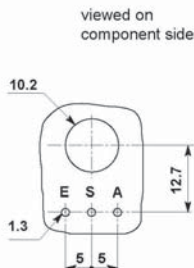
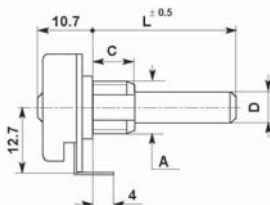

P20EC

Standard spindle & bush

L = 50 mm, plastic, F1 type
 D = 6 mm
 A = M10x0.75, C type
 C = 8 mm

Spindle and bushing variations

D mm	A mm	Available types		
		Bush	Plastic Spindle	Metal Spindle
6	M10x0.75	C, CE, CEBS	Fixed Plug-in	Fixed
4	M10x0.75 M7x0.75	C, CE C, CE	Fixed	Fixed

Spindle and bushing details, chassis piercing: see p. 108 to 111

Normalised spindles: see p. 112



Mechanical data

Rotation angle: $300^\circ \pm 5^\circ$
 Operating torque: $0.4 \div 1.5$ Ncm
 Permissible torque at end stop: 80 Ncm max
 Permissible axial spindle load: 100 N
 (5 sec max)
 Weight, std. spindle: ~ 10 g

Electrical data

Rated dissipation @ 40°C: 0.4 W linear law
 0.2 W non-linear law
 Limiting element voltage: 500 VDC
 Insulation resistance: ≥ 5 G Ω
 Insulation voltage: 1000 VAC
 Rated resistance: E3 Series; optional E6 Series
 • linear law: 100R to 4M7
 • non-linear law: 1K0 to 2M2
 Tolerance on rated resistance:
 • 100R to 1M0: $\pm 20\%$
 • over 1M0: $\pm 30\%$
 • optional (1K0 to 1M0): $\pm 10\%$
 Resistance law: A, B, C, F, T, S, X

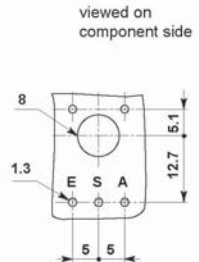
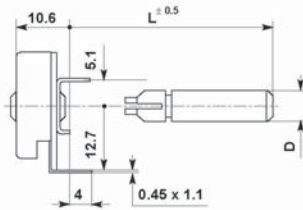
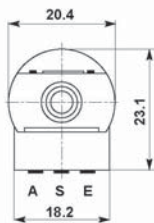

P20E

Standard spindle

L = 50 mm, plastic, plug-in E1 type
 D = 6 mm

Spindle variations

D mm	Available types	
	Plastic Spindle	Metal Spindle
6	Plug-in Removable*	Not
4	Removable*	Not

* **Removable spindle:** it can be put in and out of the potentiometer, holding strength > 1 Kg. Available spindle types are the same as fixed spindles. The removable spindle is supplied not mounted.

Spindle details: see p. 109 to 111



Mechanical data

Rotation angle:	$300^\circ \pm 5^\circ$
Operating torque:	0.4 ± 1.5 Ncm
Permissible torque at end stop:	80 Ncm max
Permissible axial spindle load:	100 N (5 sec max)
Tap:	Z2 at 50% or 57% of rotation
Weight, std. spindle:	~ 13 g

Electrical data

Rated dissipation @ 40°C:	0.4 W linear law 0.2 W non-linear law
Limiting element voltage:	500 VDC
Insulation resistance:	≥ 5 G Ω
Insulation voltage:	1000 VAC
Rated resistance: E3 Series; optional E6 Series	
• linear law:	100R to 4M7
• non-linear law:	1K0 to 2M2
Tolerance on rated resistance:	
• 100R to 1M0:	$\pm 20\%$
• over 1M0:	$\pm 30\%$
• optional (1K0 to 1M0):	$\pm 10\%$
Resistance law:	A, B, C, F, S, T, X
• with tap:	A2, B2, S2

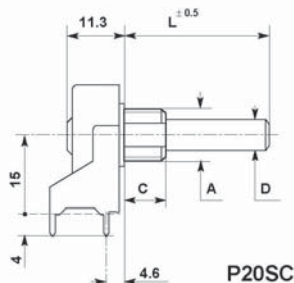
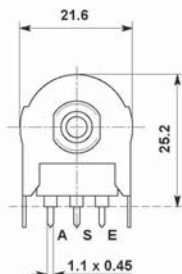

Standard spindle & bush

L = 49,5 mm, plastic, F1 type
D = 6 mm
A = M10x0.75, plastic, C type
C = 8 mm

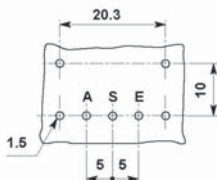

viewed on
component side

Spindle and bushing variations

D mm	A mm	Available types		
		Bush	Plastic Spindle	Metal Spindle
6	M10x0.75	C, CE, CEBS	Fixed Plug-in	Fixed
4	M10x0.75 M7x0.75	C, CE C, CE	Fixed	Fixed

Spindle and bushing details, chassis piercing: see p. 108 to 111

Normalised spindles: see p. 112



Mechanical data

Rotation angle: $300^\circ \pm 5^\circ$
 Operating torque: $0.4 \div 1.5$ Ncm
 Permissible torque at end stop: 80 Ncm max
 Permissible axial spindle load: 100 N
 (5 sec max)
 Tap: Z2 at 50% or 57% of rotation
 Weight, std. spindle: ~ 10 g

Electrical data

Rated dissipation @ 40°C: 0.4 W linear law
 0.2 W non-linear law
 Limiting element voltage: 500 VDC
 Insulation resistance: ≥ 5 G Ω
 Insulation voltage: 1000 VAC
 Rated resistance: E3 Series; optional E6 Series
 • linear law: 100R to 4M7
 • non-linear law: 1K0 to 2M2
 Tolerance on rated resistance:
 • 100R to 1M0: $\pm 20\%$
 • over 1M0: $\pm 30\%$
 • optional (1K0 to 1M0): $\pm 10\%$
 Resistance law: A, B, C, F, S, T, X,
 • with tap: A2, B2, S2

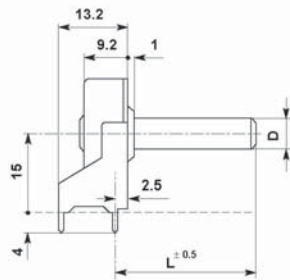
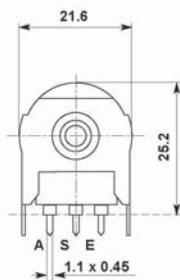

P20S

Standard spindle

L = 50 mm, plastic, F1 type
 D = 6 mm

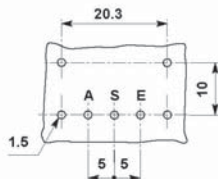

viewed on
component side

Spindle variations

D mm	Available types	
	Plastic Spindle	Metal Spindle
6	Fixed Plug-in	Fixed
4	Fixed	Fixed

Spindle details: see p. 109 to 111

Normalised spindles: see p. 112



Mechanical data

Rotation angle: $300^\circ \pm 5^\circ$
 Operating torque: 0.5 ± 1.8 Ncm
 Permissible torque at end stop: 80 Ncm max
 Permissible axial spindle load: 100 N
 (5 sec max)
 Tap: Z2 at 50% or 57% of rotation
 Weight, std. spindle: ~ 13 g

Electrical data

Rated dissipation @ 40°C :
 2×0.4 W linear law
 2×0.2 W non-linear law
 Limiting element voltage: 500 VDC
 Insulation resistance: ≥ 5 G Ω
 Insulation voltage: 1000 VAC
 Rated resistance: E3 Series; optional E6 Series
 • linear law: 100R to 4M7
 • non-linear law: 1K0 to 2M2
 Tolerance on rated resistance:
 • 100R to 1M0: $\pm 20\%$
 • over 1M0: $\pm 30\%$
 • optional (1K0 to 1M0): $\pm 10\%$
 Resistance law: A, B, C, F, S, T, X
 • with tap: A2, B2, S2
 Matching tolerance Class II

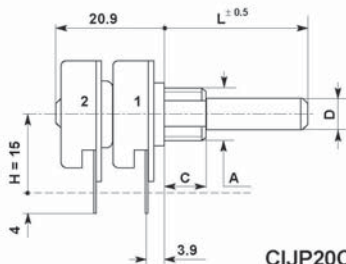
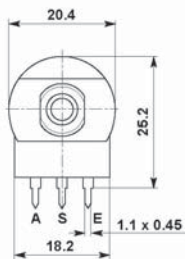

CIJP20C

Types

CIJP20C	P.c. terminations
JP20C	Solder tag terminations

Standard spindle & bush

L = 50 mm, plastic, F1 type
 D = 6 mm
 A = M10x0.75, plastic, KC type
 C = 8 mm

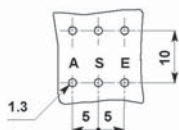

H = 22 optional

viewed on component side

Spindle and bushing variations

D mm	A mm	Available types		
		Bush	Plastic Spindle	Metal Spindle
6	M10x0.75	KC, C, CE, CEBS	Fixed Plug-in	Fixed
4	M10x0.75 M7x0.75	C, CE C, CE	Fixed	Fixed

Spindle and bushing details, chassis piercing: see p. 108 to 111

Normalised spindles: see p. 112



Carbon Rotary Potentiometers - 20 mm size

Duals

Types
CIDP20C
DP20C

Mechanical data

Rotation angle: $300^\circ \pm 5^\circ$
 Operating torque: $0.4 \div 1.8$ Ncm
 Permissible torque at end stop: 60 Ncm max
 Permissible axial spindle load: 100 N
 (5 sec max)
 Tap: Z2 at 50% or 57% of rotation
 Weight, std. spindle: ~ 27 g

Electrical data

Rated dissipation @ 40°C:
 2×0.4 W linear law
 2×0.2 W non-linear law
 Limiting element voltage: 500 VDC
 Insulation resistance: ≥ 5 G Ω
 Insulation voltage: 1000 VAC
 Rated resistance: E3 Series; optional E6 Series
 • linear law: 100R to 4M7
 • non-linear law: 1K0 to 2M2
 Tolerance on rated resistance:
 • 100R to 1M0: $\pm 20\%$
 • over 1M0: $\pm 30\%$
 • optional (1K0 to 1M0): $\pm 10\%$
 Resistance law: A, B, C, F, S, T, X
 • whitt tap: A2, B2, S2

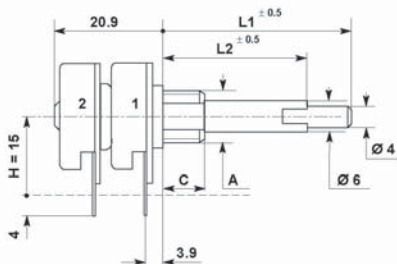
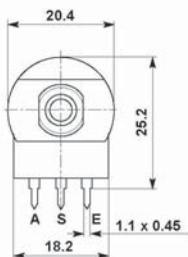
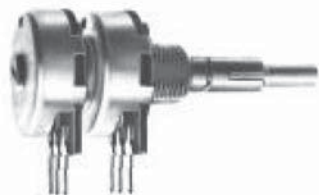

H = 22 optional

CIDP20C

viewed on component side

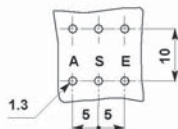

Types

CIDP20C	P.c. terminations
DP20C	Solder tag terminations

Bushing variations

A mm	Bush type
M10x0.75	C, CE, CEBS

Standard spindle & bush

L1 = 40 mm, L2 = 30 mm, metal, M15 type
 A = M10x0.75, C type
 C = 8 mm

Spindle and bushing details, chassis piercing: see p. 108 -110



Carbon Rotary Potentiometers - 20 mm size

Singles with Rotary Switch

Types
CIP20C 2IFS
P20C 2IFS

Mechanical data

Rotation angle: $300^\circ \pm 5^\circ$
 Operating torque: $0.4 \div 1.5$ Ncm
 Permissible torque at end stop: 80 Ncm max
 Permissible axial spindle load: 100 N
 (5 sec max)
 Tap: Z2 at 52% of rotation

Rotary switch:

Switching angle: $35^\circ \pm 5^\circ$
 Operating torque: $4 \div 10$ Ncm
 Weight, std. spindle: ~ 16 g

Electrical data

Rated dissipation @ 40°C : 0.4 W linear law
 0.2 W non-linear law
 Limiting element voltage: 500 VDC
 Insulation resistance: ≥ 5 G Ω
 Insulation voltage: 1000 VAC
 Rated resistance: E3 Series; optional E6 Series
 • linear law: 100R to 4M7
 • non-linear law: 1K0 to 2M2
 Tolerance on rated resistance:
 • 100R to 1M0: $\pm 20\%$
 • over 1M0: $\pm 30\%$
 • optional (1K0 to 1M0): $\pm 10\%$
 Resistance law: A, B, C, F, S, T, X
 • with tap: A2, B2

Switch:

Breaking capacity: 2A-250 VAC
 Peak current: 64A-250VAC
 Resistive load: 5A-250 VAC
 Protective classe (VDE) II

Approval:

VDE 0630

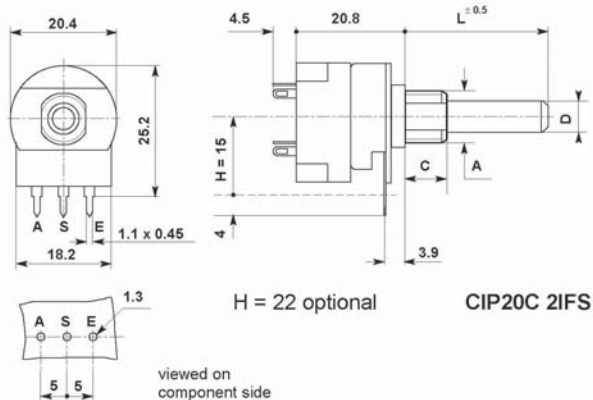

Types

CIP20C 2IFS	P.c. terminations
P20C 2IFS	Solder tag terminations

Standard spindle & bush

L = 50 mm, plastic, F1 type
 D = 6 mm
 A = M10x0.75, plastic, KC type
 C = 8 mm

Spindle and bushing details

D mm	A mm	Available types		
		Bush	Plastic Spindle	Metal Spindle
6	M10x0.75	KC, C, CE, CEBS	Fixed Plug-in	Fixed
4	M10x0.75 M7x0.75	C, CE C, CE	Fixed	Fixed

Spindle and bushing details, chassis piercing: see p. 108 to 111

Normalised spindles: see p. 112



Carbon Rotary Potentiometers - 20 mm size

Singles with Rotary Switch

Types
CIP20C IL
P20C IL
CIP20C 2IL
P20C 2IL

Mechanical data

Rotation angle: $300^\circ \pm 5^\circ$
 Operating torque: 0.4 ± 1.5 Ncm
 Permissible torque at end stop: 80 Ncm max
 Permissible axial spindle load: 100 N
 (5 sec max)
 Tap: Z2 at 52% of rotation

Rotary switch:

Switching angle: $30^\circ \pm 5^\circ$
 Operating torque: 2 ± 5 Ncm
 Weight, std. spindle: ~ 13 g



Electrical data

Rated dissipation @ 40°C : 0.4 W linear law
 0.2 W non-linear law
 Limiting element voltage: 500 VDC
 Insulation resistance: ≥ 5 G Ω
 Insulation voltage: 1000 VAC
 Rated resistance: E3 Series; optional E6 Series
 • linear law: 100R to 4M7
 • non-linear law: 1K0 to 2M2
 Tolerance on rated resistance:
 • 100R to 1M0: $\pm 20\%$
 • over 1M0: $\pm 30\%$
 • optional (1K0 to 1M0): $\pm 10\%$
 Resistance law: A, B, C, F, S, T, X
 • with tap: A2, B2

Switch: 1-pole (SPST); 2-pole (DPST)
 Breaking capacity: 1.5 A-250 VAC resist. load
 5A - 24 VDC

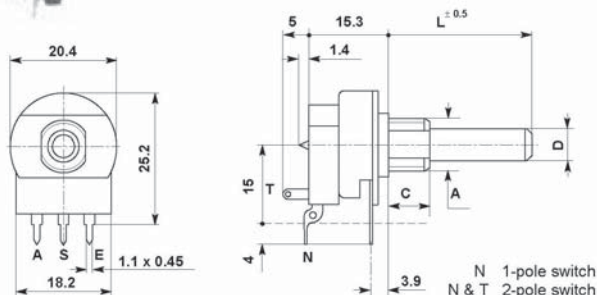

Standard spindle & bush

L = 50 mm, plastic, F1 type
 D = 6 mm
 A = M10x0.75, plastic, KC type
 C = 8 mm

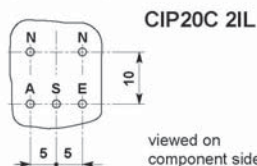

Types

CIP20C IL	1-pole switch - P.c. terminations
P20C IL	1-pole switch - Solder tag terminations
CIP20C 2IL	2-pole switch - P.c. terminations
P20C 2IL	2-pole switch - Solder tag terminations

Spindle and bushing variations

D mm	A mm	Available types		
		Bush	Plastic Spindle	Metal Spindle
6	M10x0.75	KC, C, CE, CEBS	Fixed Plug-in	Fixed
4	M10x0.75 M7x0.75	C, CE C, CE	Fixed	Fixed

Spindle and bushing details, chassis piercing: see p. 108 to 111
 Normalised spindles: see p. 112



Carbon Rotary Potentiometers - 20 mm size

Singles with Rotary Switch

Types
EP20KC IL
EP20KC 2IL

Mechanical data

Rotation angle: $300^\circ \pm 5^\circ$
 Operating torque: $0.4 \div 1.5$ Ncm
 Permissible torque at end stop: 80 Ncm max
 Permissible axial spindle load: 100 N
 (5 sec max)

Rotary switch:

Switching angle: $30^\circ \pm 5^\circ$
 Operating torque: $2 \div 5$ Ncm

Weight, std. spindle: ~ 13 g

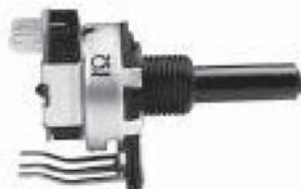

Electrical data

Rated dissipation @ 40°C : 0.4 W linear law
 0.2 W non-linear law

Limiting element voltage: 500 VDC

Insulation resistance: ≥ 5 G Ω

Insulation voltage: 1000 VAC

Rated resistance: E3 Series; optional E6 Series

• linear law: 100R to 4M7

• non-linear law: 1K0 to 2M2

Tolerance on rated resistance:

• 100R to 1M0: $\pm 20\%$

• over 1M0: $\pm 30\%$

• optional (1K0 to 1M0): $\pm 10\%$

Resistance law: A, B, C, F, T, S, X

Switch: 1-pole (SPST); 2-pole (DPST)

Breaking capacity: 1.5A - 250 VAC resist. load
 5A-24 VDC

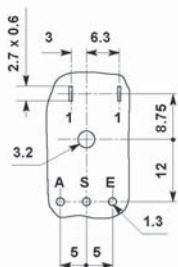

EP20KC IL
1-pole switch

viewed on
component side

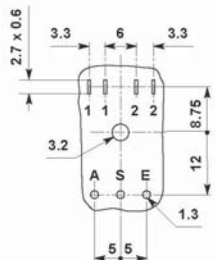
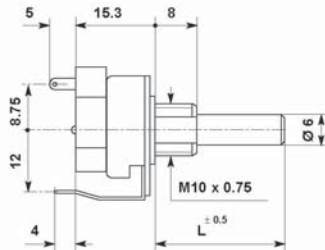
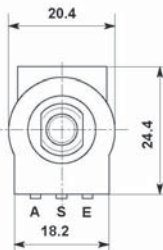

EP20KC 2IL
2-pole switch

Types

EP20KC IL	1-pole switch
EP20KC 2IL	2-pole switch

Spindles details: see p. 109 - 110.

Normalised spindles: see p. 112

Standard spindle & bush
 L = 50 mm, plastic, F1 type
 Bush KC type



Carbon Rotary Potentiometers - 20 mm size

Singles with Rotary Switch

Types
P20EC IL
P20EC 2IL

Mechanical data

Rotation angle: $300^\circ \pm 5^\circ$
 Operating torque: $0.4 \div 1.5$ Ncm
 Permissible torque at end stop: 80 Ncm max
 Permissible axial spindle load: 100 N
 (5 sec max)

Rotary switch:

Switching angle: $30^\circ \pm 5^\circ$
 Operating torque: $2 \div 5$ Ncm

Weight, std. spindle: ~ 13 g

Electrical data

Rated dissipation @ 40°C: 0.4 W linear law
 0.2 W non-linear law
 Limiting element voltage: 500 VDC
 Insulation resistance: ≥ 5 G Ω
 Insulation voltage: 1000 VAC
 Rated resistance: E3 Series; optional E6 Series
 • linear law: 100R to 4M7
 • non-linear law: 1K0 to 2M2
 Tolerance on rated resistance:
 • 100R to 1M0: $\pm 20\%$
 • over 1M0: $\pm 30\%$
 • optional (1K0 to 1M0): $\pm 10\%$
 Resistance law: A, B, C, F, T, S, X

Switch: 1-pole (SPST); 2-pole (DPST)
 Breaking capacity: 1.5A - 250 VAC resist. load
 5A-24 VDC

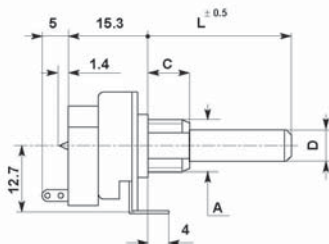
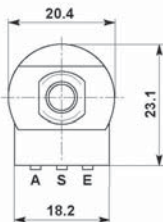

P20EC IL
P20EC 2IL

Viewed on component side

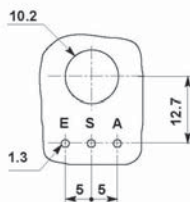

Standard spindle & bush

L = 50 mm, plastic, F1 type
 D = 6 mm
 A = M10x0.75, C type
 C = 8 mm

Types

P20EC IL	1-pole switch
P20EC 2IL	2-pole switch

Spindle and bushing variations

D mm	A mm	Available types		
		Bush	Plastic Spindle	Metal Spindle
6	M10x0.75	C, CE, CEBS	Fixed Plug-in	Fixed
4	M10x0.75 M7x0.75	C, CE C, CE	Fixed	Fixed

Spindles and bushing details, chassis piercing: see p. 108 to 111.

Normalised spindles: see p. 112.



Carbon Rotary Potentiometers - 20 mm size

Singles with Rotary Switch

Types
P21EC IL
P21EC 2IL

Mechanical data

Rotation angle: $300^\circ \pm 5^\circ$
 Operating torque: $0.4 \div 1.5$ Ncm
 Permissible torque at end stop: 80 Ncm max
 Permissible axial spindle load: 100 N
 (5 sec max)

Rotary switch:

Switching angle: $30^\circ \pm 5^\circ$
 Operating torque: $2 \div 5$ Ncm
 Weight, std. spindle: ~ 13 g

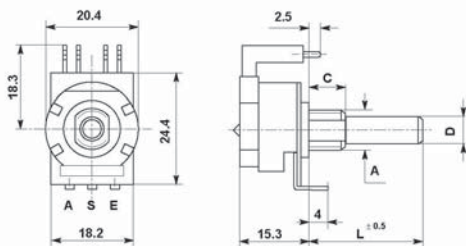
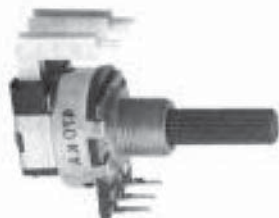

Electrical data

Rated dissipation @ 40°C : 0.4 W linear law
 0.2 W non-linear law
 Limiting element voltage: 500 VDC
 Insulation resistance: ≥ 5 G Ω
 Insulation voltage: 1000 VAC
 Rated resistance: E3 Series; optional E6 Series
 • linear law: 100R to 4M7
 • non-linear law: 1K0 to 2M2
 Tolerance on rated resistance:
 • 100R to 1M0: $\pm 20\%$
 • over 1M0: $\pm 30\%$
 • optional (1K0 to 1M0): $\pm 10\%$
 Resistance law: A, B, C, F, T, S, X

Switch: 1-pole (SPST); 2-pole (DPST)
 Breaking capacity: 1.5A - 250 VAC resist. load
 5A-24 VDC

P21EC IL
1-pole

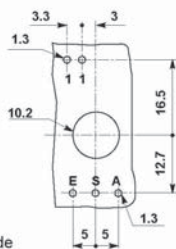

Viewed on component side

P21EC 2IL
2-pole

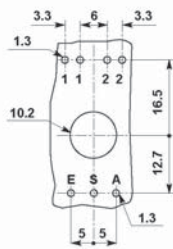

Standard spindle & bush

L = 50 mm, plastic, F1 type
 D = 6 mm
 A = M10x0.75, C type
 C = 8 mm

Types

P21EC IL	1-pole switch
P21EC 2IL	2-pole switch

Spindle and bushing variations

D mm	A mm	Available types		
		Bush	Plastic Spindle	Metal Spindle
6	M10x0.75	C, CE, CEBS	Fixed Plug-in	Fixed
4	M10x0.75 M7x0.75	C, CE C, CE	Fixed	Fixed

Spindles and bushing details, chassis piercing: see p. 108 to 111.

Normalised spindles: see p. 112.



Carbon Rotary Potentiometers - 20 mm size

Singles with Rotary Switch

Type
P20SC 21FS

Mechanical data

Rotation angle: $300^\circ \pm 5^\circ$
 Operating torque: $0.4 \div 1.5$ Ncm
 Permissible torque at end stop: 80 Ncm max
 Permissible axial spindle load: 100 N
 (5 sec max)
 Tap: Z2 at 52% of rotation

Rotary switch:

Switching angle: $35^\circ \pm 5^\circ$
 Operating torque: $4 \div 10$ Ncm
 Weight, std. spindle: ~ 16 g

Electrical data

Rated dissipation @ 40°C: 0.4 W linear law
 0.2 W non-linear law

Limiting element voltage: 500 VDC
 Insulation resistance: ≥ 5 GΩ
 Insulation voltage: 1000 VAC
 Rated resistance: E3 Series; optional E6 Series
 • linear law: 100R to 4M7
 • non-linear law: 1K0 to 2M2
 Tolerance on rated resistance:
 • 100R to 1M0: $\pm 20\%$
 • over 1M0: $\pm 30\%$
 • optional (1K0 to 1M0): $\pm 10\%$
 Resistance law: A, B, C, F, S, T, X
 • with tap: A2, B2

Switch:

2-pole (DPST)
 Breaking capacity: 2A-250 VAC
 Peak current: 64A-250VAC
 Resistive load: 5A-250 VAC
 Protective classe (VDE) II

Approval:

VDE 0630

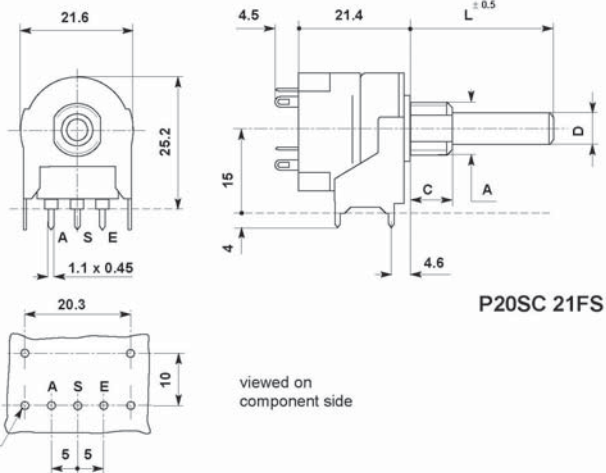
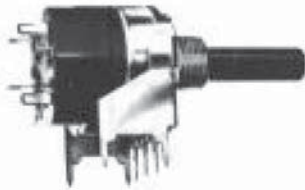

Standard spindle & bush

L = 49.5 mm, plastic, F1 type
 D = 6 mm
 A = M10x0.75, C type
 C = 8 mm

P20SC 21FS

Spindle and bushing variations

D mm	A mm	Available types		
		Bush	Plastic Spindle	Metal Spindle
6	M10x0.75	C, CE, CEBS	Fixed Plug-in	Fixed
4	M10x0.75 M7x0.75	C, CE C, CE	Fixed	Fixed

Spindles and bushing details, chassis piercing: see p. 108 to 111.

Normalised spindles: see p. 112.



Carbon Rotary Potentiometers - 20 mm size

Singles with Rotary Switch

Types
P20SC IL
P20SC 2IL

Mechanical data

Rotation angle: $300^\circ \pm 5^\circ$
 Operating torque: $0.4 \div 1.5$ Ncm
 Permissible torque at end stop: 80 Ncm max
 Permissible axial spindle load: 100 N
 (5 sec max)
 Tap: Z2 at 52% of rotation

Rotary switch:

Switching angle: $30^\circ \pm 5^\circ$
 Operating torque: $2 \div 5$ Ncm

Weight, std. spindle: ~ 13 g

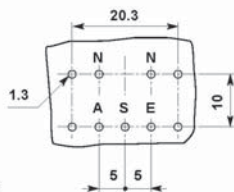

viewed on component side

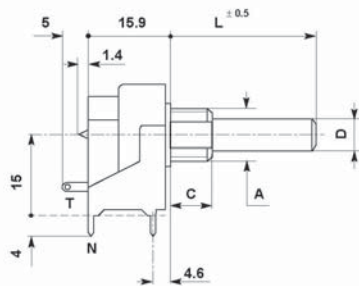
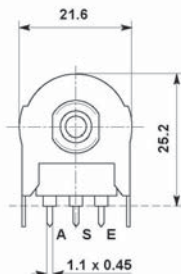

N 1-pole switch
 N & T 2-pole switch

P20SC 2IL

Standard spindle & bush

L = 49.5 mm, plastic, F1 type
 D = 6 mm
 A = M10x0.75, C type
 C = 8 mm

Spindle and bushing variations

D mm	A mm	Available types		
		Bush	Plastic Spindle	Metal Spindle
6	M10x0.75	C, CE, CEBS	Fixed Plug-in	Fixed
4	M10x0.75 M7x0.75	C, CE C, CE	Fixed	Fixed

Electrical data

Rated dissipation @ 40°C: 0.4 W linear law
 0.2 W non-linear law
 Limiting element voltage: 500 VDC
 Insulation resistance: ≥ 5 GΩ
 Insulation voltage: 1000 VAC
 Rated resistance: E3 Series; optional E6 Series
 • linear law: 100R to 4M7
 • non-linear law: 1K0 to 2M2
 Tolerance on rated resistance:
 • 100R to 1M0: $\pm 20\%$
 • over 1M0: $\pm 30\%$
 • optional (1K0 to 1M0): $\pm 10\%$
 Resistance law: A, B, C, F, S, T, X
 • with tap: A2, B2

Switch:

1-pole (SPST); 2-pole (DPST)
 Breaking capacity: 1.5 A - 250 VAC resist. load
 5A - 24 VDC

Types

P20SC IL	1-pole switch
P20SC 2IL	2-pole switch

Spindle and bushing details, chassis piercing: see p. 108 to 111.

Normalised spindles: see p. 112.



Carbon Rotary Potentiometers - 20 mm size

Singles with Rotary Switch

Types
P20S 1L
P20S 2IL

Mechanical data

Rotation angle: $300^\circ \pm 5^\circ$
 Operating torque: $0.4 \div 1.5$ Ncm
 Permissible torque at end stop: 80 Ncm max
 Permissible axial spindle load: 100 N
 (5 sec max)
 Tap: Z2 at 52% of rotation

Rotary switch:

Switching angle: $30^\circ \pm 5^\circ$
 Operating torque: $2 \div 5$ Ncm

Weight, std. spindle: ~ 12 g

Electrical data

Rated dissipation @ 40°C : 0.4 W linear law
 0.2 W non-linear law

Limiting element voltage: 500 VDC
 Insulation resistance: ≥ 5 G Ω
 Insulation voltage: 1000 VAC
 Rated resistance: E3 Series; optional E6 Series
 • linear law: 100R to 4M7
 • non-linear law: 1K0 to 2M2

Tolerance on rated resistance:
 • 100R to 1M0: $\pm 20\%$
 • over 1M0: $\pm 30\%$
 • optional (1K0 to 1M0): $\pm 10\%$
 Resistance law: A, B, C, F, S, T, X
 • with tap: A2, B2

Switch: 1-pole (SPST); 2-pole (DPST)
 Breaking capacity: 1.5 A - 250 VAC resist. load
 5A - 24 VDC

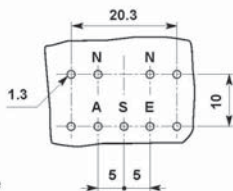

viewed on component side

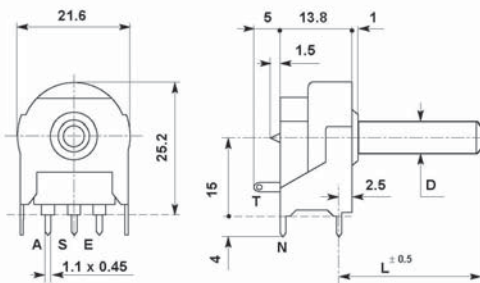

N 1-pole switch
 N & T 2-pole switch

P20S 2IL

Types

P20S 1L	1-pole switch
P20S 2IL	2-pole switch

Spindle variations

D mm	Available types	
	Plastic Spindle	Metal Spindle
6	Fixed Plug-in	Fixed
4	Fixed	Fixed

Standard spindle

L = 50 mm, plastic, F1 type
 D = 6 mm

Spindle details: see p. 109 to 111.

Normalised spindles: see p. 112.



Mechanical data

Rotation angle: $300^\circ \pm 5^\circ$
 Operating torque: $0.4 \div 1.5$ Ncm
 Permissible torque at end stop: 35 Ncm max
 Weight: ~ 5 g

Electrical data

Rated dissipation @ 40°C : 0,4 W linear law
 0,2 W non-linear law
 Limiting element voltage: 500 VDC
 Insulation resistance: ≥ 5 G Ω
 Insulation voltage: 1000 VAC
 Rated resistance: E3 Series; optional E6 Series
 • linear law: 100R to 4M7
 • non-linear law: 1K0 to 2M2
 Tolerance on rated resistance:
 • 100R to 1M0: $\pm 20\%$
 • over 1M0: $\pm 30\%$
 • optional (1K0 to 1M0): $\pm 10\%$
 Resistance law: A, B, C, F, S, X

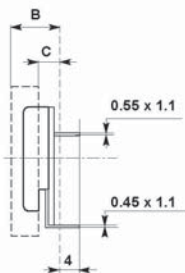
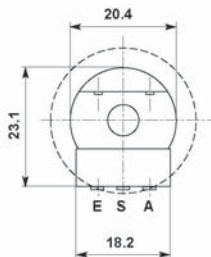

viewed on component side

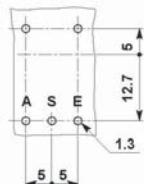

P20M

Potentiometers are supplied without knob
 Knobs are supplied on request, not mounted

knob type	B = mm	C = mm
D30	11.1	4.9
D40	11.5	4.7

Plastic knobs

Colour: grey

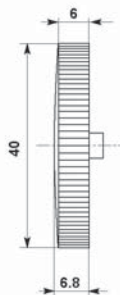

D40

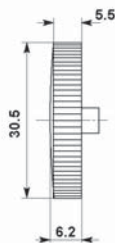

D30



Mounting bushes

Type	Chassis piercing		D	C		
				std.	opt.	
C Metal				6 4	8 8	12
KC Plastic				6	8	—
C Metal				4	6	9
CE Metal				6 4	8 8	12
CE Metal				4	6	9
CEBS Metal				6	8,5	—

Potentiometers with bush are supplied with a nut, not mounted. Available bushes are specified on the pages describing each potentiometer type.



Carbon Rotary Potentiometers - 20 mm size

Spindle variations - 6 mm diameter	available types		
	plastic		fixed metal
	fixed	plug-in	
<p>$D = 6^{+0.01}_{-0.075}$</p> <p>Mounting face</p> <p>$L = 15 \text{ to } 60$</p> <p>$L \pm 0.5$</p>	F1	E1 L = 23 min	M1
<p>$D = 6^{+0.01}_{-0.075}$</p> <p>12</p> <p>$4^{0}_{-0.1}$</p> <p>$L = 15 \text{ to } 60$</p> <p>$L \pm 0.5$</p> <p>205° optional 210°</p> <p>spindle in full CCW position</p>	F2	E2 L = 23 min	M2
<p>$D = 6^{+0.01}_{-0.075}$</p> <p>A</p> <p>$5^{+0.03}_{-0.05}$</p> <p>$L = 15 \text{ to } 60$</p> <p>$L \pm 0.5$</p> <p>205° optional 210°</p> <p>spindle in full CCW position</p>	F3 A = 15	E3 A = 15 L = 23 min	M3 A = 15
<p>A = 15 - L = 20 to 60 A = 10 - L = 15 to 60</p>	F4 A = 10	NOT	M4 A = 10

The orientation of the flat indicated in the drawings is for plastic spindles only. For metal spindles, unless specified in the order, the orientation of the flat may change in each potentiometer.

Fixed spindle: it is permanently attached to the potentiometer.

Plug-in spindle: (Patented system) It can be incorporated into the potentiometer after its assembly or bath-soldering. Once inserted, cannot be removed. A force > 10 Kg is required to separate the spindle from the potentiometer after insertion.

Available spindles are specified on the pages describing each potentiometer type.



Carbon Rotary Potentiometers - 20 mm size

Spindle variations- 6 mm diameter	available types		
	plastic		fixed metal
	fixed	plug-in	
<p>A = 10 - L = 15 to 60 A = 15 - L = 20 to 60 A = 20 - L = 25 to 60</p>	F10 A = 10	NOT	M10 A = 10
	F11 A = 15	E11 A = 15	M11 A = 15
	F12 A = 20	E12 A = 20	M12 A = 20
<p>A = 10 or 6 L = 10 to 60</p>	F5 18 teeth	E5 L = 23 min	NOT
	F6 24 teeth	E6 L = 23 min	NOT

The orientation of the flat indicated in the drawings is for plastic spindles only. For metal spindles, unless specified in the order, the orientation of the flat may change in each potentiometer.

Fixed spindle and plug-in spindle: see p. 109.

Separate concentric spindle	Type
<p>L1 = 60 max L2 = 50 max</p>	M15 fixed metal

Spindle variations - 4 mm diameter	available types		
	plastic		fixed metal
	fixed	plug-in	
<p>$D = 4^{+0.03}_{-0.05}$</p> <p>Mounting face</p> <p>$L = 8 \text{ to } 60$</p> <p>$L = 0.5$</p>	F21	NOT	M21
<p>$D = 4^{+0.03}_{-0.05}$</p> <p>$A = 8.5$</p> <p>$L = 11 \text{ to } 60$</p> <p>$A = 13.5$ $L = 16 \text{ to } 60$</p> <p>205°</p> <p>spindle in full CCW position</p>	F22	NOT	M22
<p>$D = 4^{+0.03}_{-0.05}$</p> <p>$A = 13.5$</p> <p>$L = 11 \text{ to } 60$</p> <p>$A = 13.5$ $L = 16 \text{ to } 60$</p> <p>205°</p> <p>spindle in full CCW position</p>	F23	NOT	M23
<p>$D = 4^{+0.03}_{-0.05}$</p> <p>6</p> <p>1.5</p> <p>1</p> <p>10</p> <p>M7 x 0.75</p> <p>205°</p> <p>spindle in full CCW position</p>	F25	NOT	M25

The orientation of the flat indicated in the drawings is for plastic spindles only. For metal spindles, unless specified in the order, the orientation of the flat may change in each potentiometer.

Fixed spindle and plug-in spindle: see p. 109.

Available spindles are specified on the pages describing each potentiometer type.



Carbon Rotary Potentiometers - 20 mm size

Normalised plastic spindles

Standard types & lengths

Potentiometer Types	D mm	Spindle types	Normalised lengths L = mm										
			15	18	20	22	25	30	35	40	50	60	
(CI) P20C	6	F1 - F2 - F3 - F6	15	18	20	22	25	30	35	40	50	60	
(CI) P20C IL (CI) P20C 2IL	6	F1 - F2 - F3 - F6	15	18	20	22	25	30	35	40	50	60	
(CI) P20C 2IFS	6	F1 - F2 - F3 - F6	15	18	20	22	25	30	35	40	50	60	
(CI) P20PD	6	F1 - F2 - F3 - F6	⁽¹⁾ 10	15	18	20	22	25	30	35	40	50	60
(CI) JP20C	6	F1 - F2 - F3 - F6	15	18	20	22	25	30	35	40	50	60	
EP20	6	F1 - F2 - F3 - F6	⁽¹⁾ 18	20	22	25	30	35	40	50	60		
EP20KC IL EP20KC 2IL	6	F1 - F2 - F3 - F6	15	18	20	22	25	30	35	40	50	60	
P20EC	6	F1 - F2 - F3 - F6	15	18	20	22	25	30	35	40	50	60	
P20EC IL P20EC 2IL	6	F1 - F2 - F3 - F6	15	18	20	22	25	30	35	40	50	60	
P21EC IL P21EC 2IL	6	F1 - F2 - F3 - F6	15	18	20	22	25	30	35	40	50	60	
P20EPD	6	F1 - F2 - F3 - F6	⁽¹⁾ 10	15	18	20	22	25	30	35	40	50	60
P20S	6	F1 - F2 - F3 - F6	14	19	22	24	26	29	34	39	44	50	54
P20S IL P20S 2IL	6	F1 - F2 - F3 - F6	14	19	22	24	26	29	34	39	44	50	54
P20SC	6	F1 - F2 - F3 - F6	14.5	17.5	19.5	21.5	24.5	29.5	34.5	39.5	49.5	59.5	
P20SC IL P20SC 2IL	6	F1 - F2 - F3 - F6	14.5	17.5	19.5	21.5	24.5	29.5	34.5	39.5	49.5	59.5	
P20SC 2IFS	6	F1 - F2 - F3 - F6	14.5	17.5	19.5	21.5	24.5	29.5	34.5	39.5	49.5	59.5	
SP20	6	F1 - F2 - F3 - F6	18	21	26	36	41	46	50	56			

(1) F6 type only

F2-F3 types: with flat in standard position



Carbon Rotary Potentiometers - 20 mm size

Mechanical position of the taps

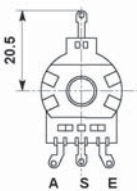
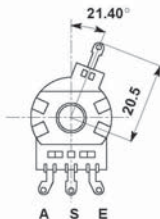
				
	Without switch	Without switch	Without switch	With switch
Tap	Z2	Z2	Z2	Z2
Resistance law	A2, S2	B2	A2, B2	A2, B2
% Rotation (ϕ Z)	50%	57%	52%	52%

Tap termination is the same both for P.c. and solder potentiometers.
Obtainable tap is specified on the pages describing each potentiometer type.

Mounting accessories

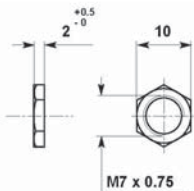
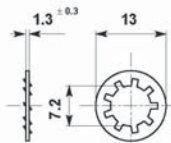
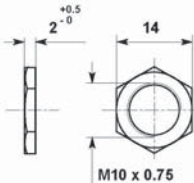
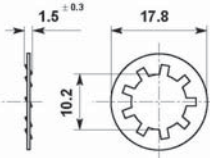
Bushes M7	NUT M7  M7 x 0.75	LOCKWASHER M7 
Bushes M10	NUT M10  M10 x 0.75	LOCKWASHER M10 

Potentiometers with bush are supplied with a nut, not mounted.
The toothed lockwasher is supplied on request only, not mounted.



How to order

Désignation pour passer une commande

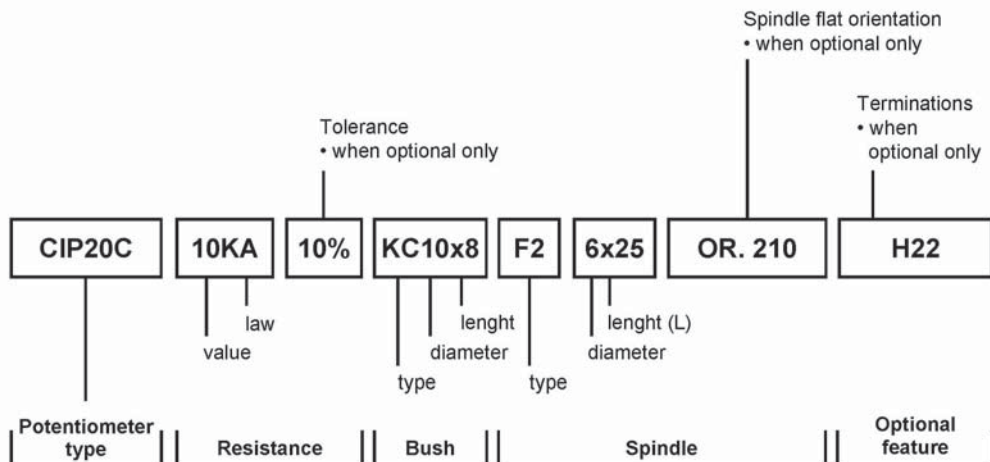

- Resistance laws: see p. 29 to 34.
- Bushes: see p. 108.
- Spindles: see p. 109 to 111.

Available resistance values, resistance laws, optional tolerance, spindle types and optional features are specified on the pages describing each potentiometer type.



24 mm travel

Course 24 mm

40 mm travel

Course 40 mm

58 mm travel

Course 58 mm

How to order

Désignation pour passer une commande



Carbon Slider Potentiometers

24 mm travel

Type
PG 24

Mechanical data

Travel:	24 mm
Operating force:	0.6 + 1.8 N
Permissible force at end stop:	50 N max
Permissible lateral force on spindle, perpendicular to the direction of movement:	20 N max
Permissible axial force on spindle, push and pull:	40 N (5 sec max)
Permissible torque on spindle:	30 Ncm max
Weight:	~ 3 g

Electrical data

Rated dissipation @ 40°C:	0.3 W linear law
	0.15 W non-linear law
Limiting element voltage:	300 VDC
Insulating resistance:	≥ 5 GΩ
Insulating voltage:	500 VAC
Rated resistance: E3 Series; optional E6 Series	
• linear law:	220R to 4M7
• non-linear law:	1K0 to 2M2
Tolerance on rated resistance:	
• 220R to 1M0:	± 20%
• over 1M0:	± 30%
• optional (1K0 to 1M0):	± 10%
Resistance law:	A, B, C, F, S, T

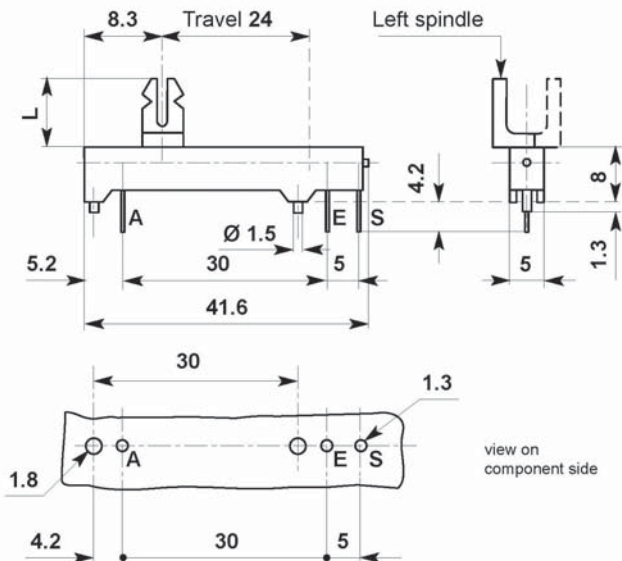

view on component side

Ordering numbers

PG 24

- 1 - Left spindle type 15
- 2 - Right spindle type 15
- 3 - Left spindle type 16
- 4 - Right spindle type 16
- 5 - Left spindle type 17
- 6 - Right spindle type 17
- 7 - Central spindle type 17

Standard type: PG 243

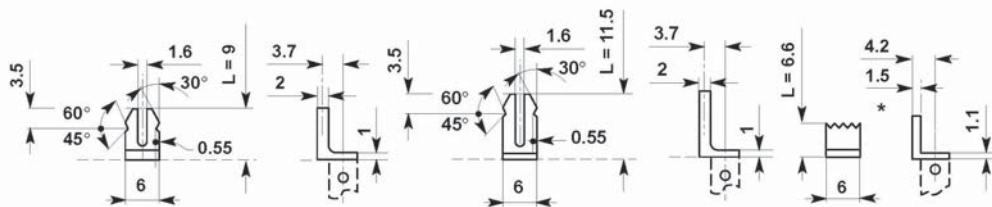

spindle type 16
standard

spindle type 15
optional

*2 mm for central type
spindle type 17
optional



Carbon Slider Potentiometers

24 mm travel

Type
PG 24B

Mechanical data

Travel:	24 mm
Operating force:	1 ± 2.5 N
Permissible force at end stop:	50 N max
Permissible lateral force on spindle, perpendicular to the direction of movement:	20 N max
Permissible axial force on spindle, push and pull:	40 N (5 sec max)
Permissible torque on spindle:	30 Ncm max
Weight:	~ 5 g

Electrical data

Rated dissipation @ 40°C:	0.3 W linear law	0.15 W non-linear law
Limiting element voltage:	300 VDC	
Insulating resistance:	≥ 5 GΩ	
Insulating voltage:	500 VAC	
Rated resistance: E3 Series; optional E6 Series		
• linear law:	220R to 4M7	
• non-linear law:	470R to 2M2	
Tolerance on rated resistance:		
• 220R to 1M0:	± 20%	
• over 1M0:	± 30%	
• optional (1K0 to 1M0):	± 10%	
Resistance law:	A, B, C, F, S, T	

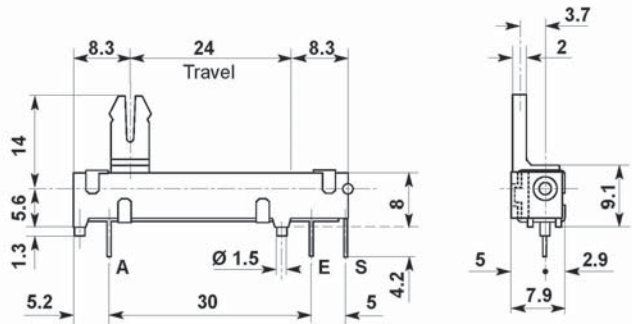

PG24B

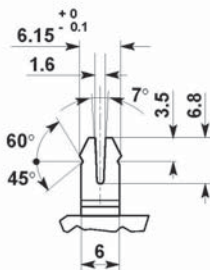

Spindle details

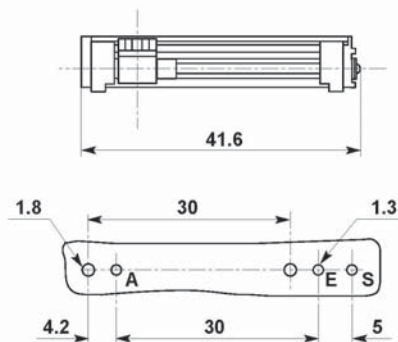

viewed on
component side



Carbon Slider Potentiometers

40 mm travel

Types
CIPGP 40
PGP 40

Mechanical data

Travel:	40 mm
Operating force:	0.6 ÷ 1.8 N
Permissible force at end stop:	50 N max
Permissible lateral force on spindle, perpendicular to the direction of movement:	20 N max
Permissible axial force on spindle, push and pull:	40 N (5 sec max)
Permissible torque on spindle:	30 Ncm max
Weight:	~ 8 g

Mounting facilities

- P.c. terminations type: welding terminations on printed circuit board
- Solder tag terminations type: self-tapping screws \varnothing 2.84 mm

Optional feature

- central click

Electrical data

Rated dissipation @ 40°C:	0.3 W linear law 0.15 W non-linear law
Limiting element voltage:	350 VDC
Insulation resistance:	$\geq 5 \text{ G}\Omega$
Insulation voltage:	500 VAC
Rated resistance: E3 Series; optional E6 Series	
• linear law:	220R to 4M7
• non-linear law:	1K0 to 2M2
Tolerance on rated resistance:	
• 220R to 1M0:	$\pm 20\%$
• over 1M0:	$\pm 30\%$
Resistance law:	A, B, C, F, S, T

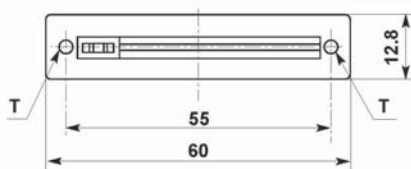
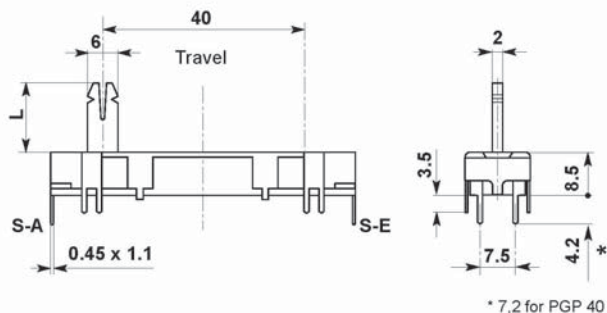

CIPGP 40

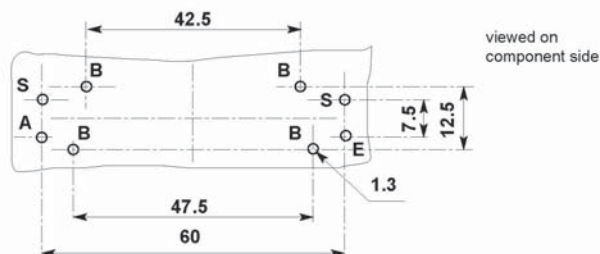

B = screening terminations

Standard types

P.c. terminations: CIPGP 40 00
Solder tag terminations: PGP 40 10



Types & ordering numbers

CIPGP 40	x x	P.c. terminations
PGP 40	x x	Solder tag terminations

- 0 - Without holes T
- 1 - Holes T for self-tapping screw
Ø 2.84 mm
- 2 - Holes T Ø 3.2 mm

- 0 - Spindle type 5
- 1 - Spindle type 6
- 2 - Spindle type 11
- 3 - Spindle type 14

Spindle variations

Plastic

Thickness 2 mm

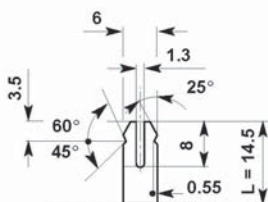

Spindle type 5
Standard

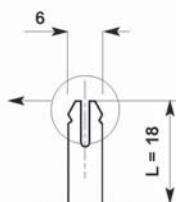

Spindle type 11
Optional

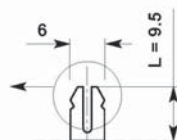

Spindle type 14
Optional

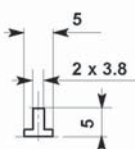

Spindle type 6
Optional



Carbon Slider Potentiometers

40 mm travel

Types
CIPGR 40
PGR 40

Mechanical data

Travel:	40 mm
Operating force:	0.6 ± 1.8 N
Permissible force at end stop:	50 N max
Permissible lateral force on spindle, perpendicular to the direction of movement:	20 N max
Permissible axial force on spindle, push and pull:	40 N (5 sec max)
Permissible torque on spindle:	30 Ncm max
Tap:	Z2 at 50% of travel
Weight:	~ 8 g

Mounting facilities

- P.c. terminations type: welding terminations on printed circuit board
- Solder tag terminations type: self-tapping screws $\varnothing 2.84$ mm

Optional feature

- Central click

Electrical data

Rated dissipation @ 40°C:	0.3 W linear law 0.15 W non-linear law
Limiting element voltage:	350 VDC
Insulation resistance:	≥ 5 G Ω
Insulation voltage:	500 VAC
Rated resistance: E3 Series; optional E6 Series	
• linear law:	$220R \pm 4M7$
• non-linear law:	$470R \pm 2M2$
Tolerance on rated resistance:	
• 220R to 1M0:	$\pm 20\%$
• over 1M0:	$\pm 30\%$
Resistance law:	A, B, C, F, S, T, X
• with tap:	A2, B2, C2, S2

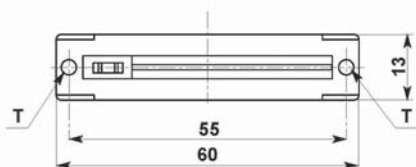
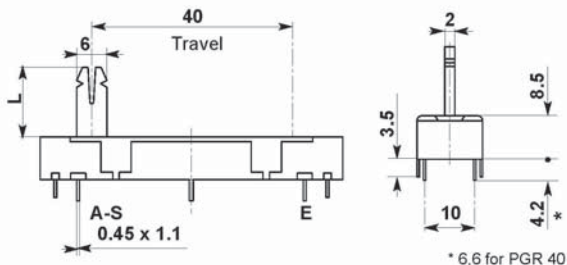
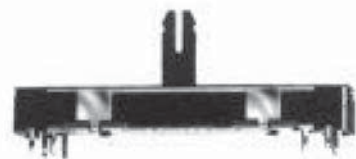

CIPGR 40

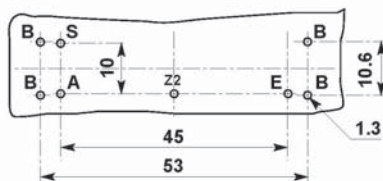

viewed on component side

Standard types

P.c. terminations: CIPGR 40 00
Solder tag terminations: PGR 40 10

B = screening terminations



Types & ordering numbers

CIPGR 40	x x	P.c. terminations
PGR 40	x x	Solder tag terminations

- 0 - Without holes T
- 1 - Holes T for self-tapping screw
Ø 2.84 mm
- 2 - Holes T Ø 3.2 mm

- 0 - Spindle type 5
- 1 - Spindle type 6
- 2 - Spindle type 11
- 3 - Spindle type 12
- 4 - Spindle type 14

Spindle variations

Plastic

Thickness 2 mm

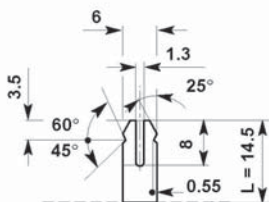

Spindle type 5
Standard

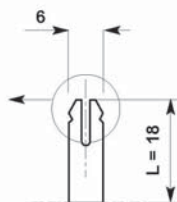

Spindle type 11
Optional

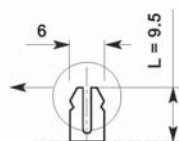

Spindle type 14
Optional

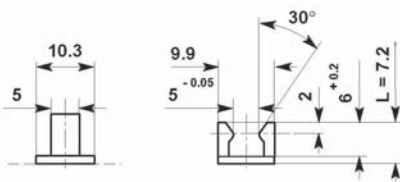

Spindle type 12
Optional

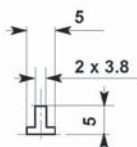

Spindle type 6
Optional



Carbon Slider Potentiometers

40 mm travel

Types
CIPGST 40M
PGST 40M
CIPGST 40S
PGST 40S

Mechanical data

Travel:	40 mm
Operating force:	0.7 ± 2 N
Permissible force at end stop:	50 N max
Permissible lateral force on spindle, perpendicular to the direction of movement:	20 N max
Permissible axial force on spindle, push and pull:	50 N (5 sec max)
Permissible torque on spindle:	30 Ncm max
Tap:	Z2 at 50% of travel
Weight:	~ 10 g

Optional features

- Central click
- Additional fixing tag, for CIPGST40M types only

Electrical data

Rated dissipation @ 40°C:	0.3 W linear law 0.15 W non-linear law
Limiting element voltage:	350 VDC
Insulation voltage:	500 VAC
Rated resistance: E3 Series; optional E6 Series	
• linear law:	220R to 4M7
• non-linear law:	470R to 2M2
Tolerance on rated resistance:	
• 220R to 1M0:	± 20%
• over 1M0:	± 30%
Resistance law:	A, B, C, F, S, T, X
• with tap:	A2, B2, C2, S2

Stereo types

Matching:	class II
• optional:	class I

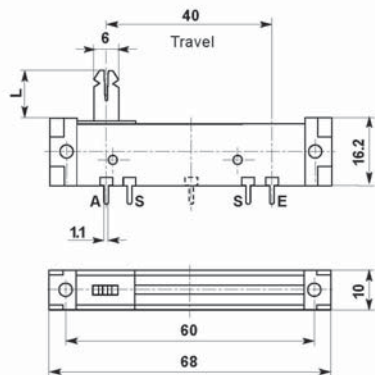

viewed on component side

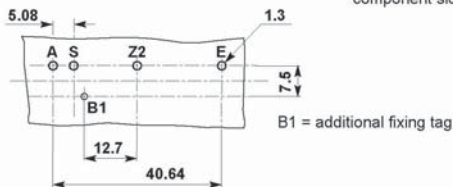

CIPGST 40M

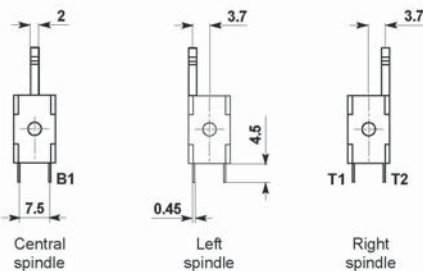

View from the beginning of travel side

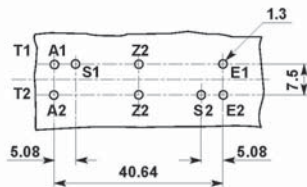

CIPGST 40S



Looking the potentiometer with terminations down, from the side with the marking, terminal A1 is situated on the left of the opposite side.



Carbon Slider Potentiometers

40 mm travel

Types
CIPGST 40M
PGST 40M
CIPGST 40S
PGST 40S

Single types

CIPGST 40M	P.c. terminations
PGST 40M	Solder tag terminations

Standard types

P.c. terminations: CIPGST 40 0100M
Solder tag terminations: PGST 40 0100M

Stereo types

CIPGST 40S	P.c. terminations
PGST 40S	Solder tag terminations

Standard types

P.c. terminations: CIPGST 40 0100S
Solder tag terminations: PGST 40 0100S

Fixing nut variations

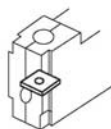

Pos. 1

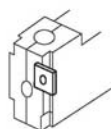

Pos. 2

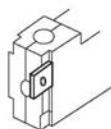

Pos. 3

M3 screw mounting from: top or bottom
(Pos. 1), small vertical sides (Pos. 2), front
or back (Pos. 3)

Spindle variations

Plastic
Thickness 2 mm

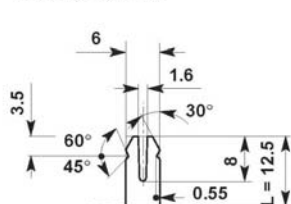

Spindle type 7
Standard

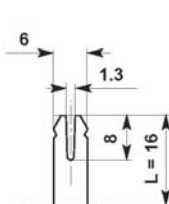

Spindle type 8
Optional

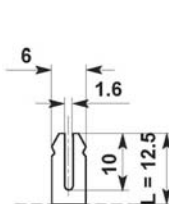

Spindle type 9
Optional

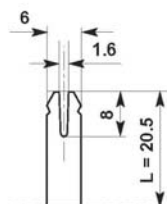

Spindle type 10
Optional

Ordering numbers

(CI) PGST 40 X X 0 X M
(CI) PGST 40 X X 0 0 S

- 0 - Central spindle type 7
- 1 - Left spindle type 7
- 2 - Right spindle type 7
- 3 - Central spindle type 8
- 4 - Left spindle type 8
- 5 - Right spindle type 8
- 6 - Central spindle type 9
- 7 - Left spindle type 10
- 8 - Right spindle type 10

- Single types only
- 0 - Without additional fixing tag
- 2 - With additional fixing tag

- 0 - Without nuts
- 1 - Nuts pos. 1
- 2 - Nuts pos. 2
- 3 - Nuts pos. 3



Carbon Slider Potentiometers

40 mm travel

Dust Protection

Types
CIPGST 44
PGST 44

Mechanical data

Travel:	40 mm
Operating force:	0.7 ÷ 2 N
Permissible force at end stop:	50 N max
Permissible lateral force on spindle, perpendicular to the direction of movement:	20 N max
Permissible axial force on spindle, push and pull:	50 N (5 sec max)
Permissible torque on spindle:	30 Ncm max
Tap:	Z2 at 50% of travel
Weight:	~ 10 g

Optional features

- Central click
- Start travel click
- End travel click
- Click in 10 positions: the first and the last one are on the start and on the end of travel



Electrical data

Rated dissipation @ 40°C:	0.3 W linear law	0.15 W non-linear law
Limiting element voltage:	350 VDC	
Insulation voltage:	500 VAC	
Rated resistance: E3 Series; optional E6 Series		
• linear law:	220R to 4M7	
• non-linear law:	470R to 2M2	
Tolerance on rated resistance:		
• 220R to 1M0:	± 20%	
• over 1M0:	± 30%	
Resistance law:	A, B, C, F, S, T, X	
• with tap:	A2, B2, C2, S2	

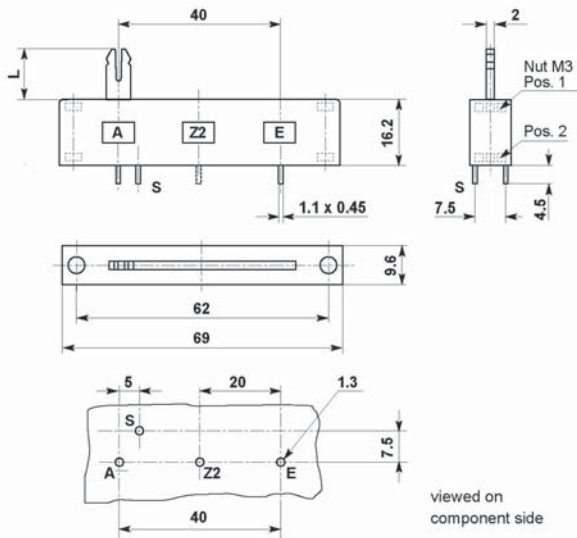

Types

CIPGST 44 P.c. terminations

PGST 44 Solder tags terminations

Standard types

P.c. terminations: CIPGST 44010

Solder tag terminations: PGST 44010

Ordering numbers

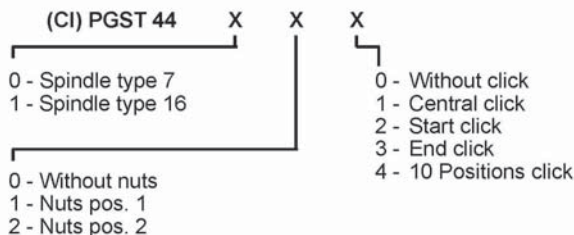



Carbon Slider Potentiometers

40 mm travel Dust Protection

Type
PGST 44H

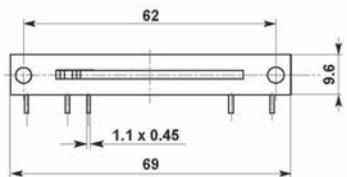
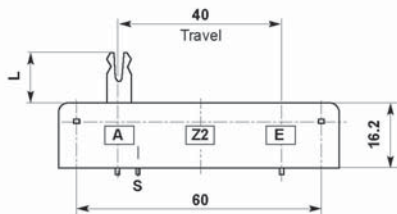

viewed on component side

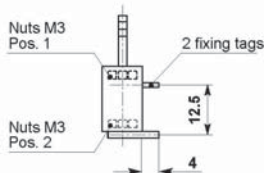

PGST 44H

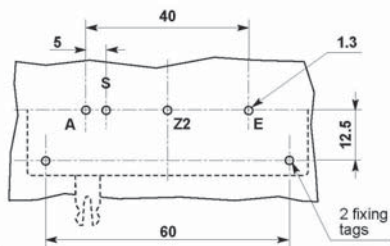

Ordering numbers

Standard type: PGST 44H000

PGST 44H X X X

- 0 - Spindle type 7
- 1 - Spindle type 16

- 0 - Without nuts
- 1 - Nuts pos. 1
- 2 - Nuts pos. 2

- 0 - Without click
- 1 - Central click
- 2 - Start click
- 3 - End click
- 4 - 10 Positions click

Spindle variations

Plastic
Thickness 2 mm

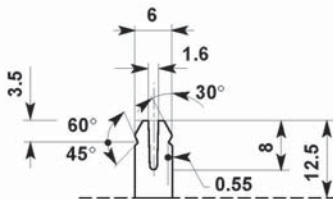

Spindle type 7
Standard

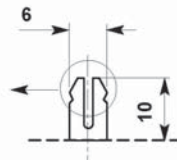

Spindle type 16
Optional



Carbon Slider Potentiometers

58 mm travel

Types
CIPGP 58
PGP 58

Mechanical data

Travel:	58 mm
Operating force:	0.6 ± 1.8 N
Permissible force at end stop:	50 N max
Permissible lateral force on spindle, perpendicular to the direction of movement:	20 N max
Permissible axial force on spindle, push and pull:	40 N (5 sec max)
Permissible torque on spindle:	30 Ncm max
Weight:	~11 g

Mounting facilities

- P.c. terminations type: welding terminations on printed circuit board
- Solder tag terminations type: self-tapping screws $\varnothing 2.84$ mm

Optional feature

- Central click

Electrical data

Rated dissipation @ 40°C:	0,4 W linear law 0,2 W non-linear law
Limiting element voltage:	500 VDC
Insulation resistance:	≥ 5 G Ω
Insulation voltage:	500 VAC
Rated resistance: E3 Series; optional E6 Series	
• linear law:	220R to 4M7
• non-linear law:	1K0 to 2M2
Tolerance on rated resistance:	
• 220R to 1M0:	$\pm 20\%$
• over 1M0:	$\pm 30\%$
Resistance law:	A, B, C, F, S, T

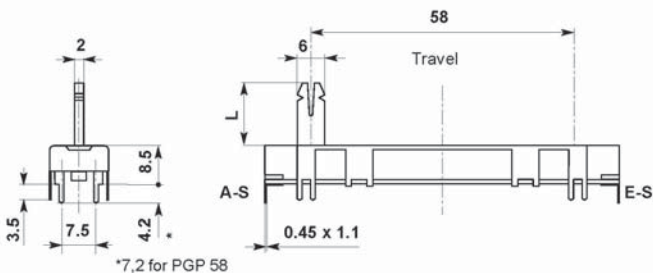

*7,2 for PGP 58

CIPGP 58

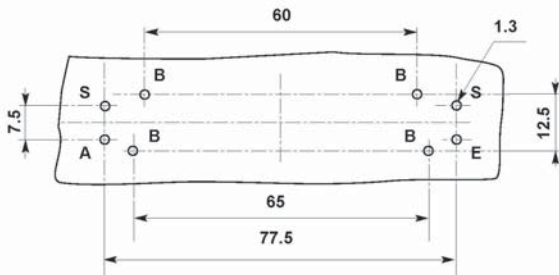
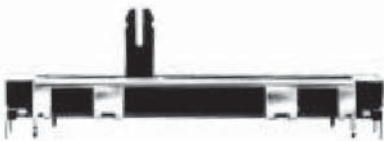

viewed on
component side

B = screening terminations

Standard types

P.c. terminations: CIPGP 58 00
Solder tag terminations: PGP 58 10



Types & ordering numbers

CIPGP 58	x x	P.c. terminations
PGP 58	x x	Solder tag terminations

- 0 - Without holes T
- 1 - Holes T for self-tapping screw
Ø 2.84 mm
- 2 - Holes T Ø 3.2 mm

- 0 - Spindle type 5
- 1 - Spindle type 6
- 2 - Spindle type 11
- 3 - Spindle type 14

Spindle variations

Plastic

Thickness 2 mm

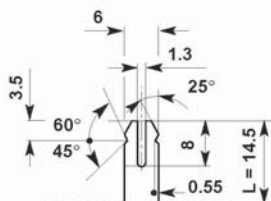

Spindle type 5
Standard

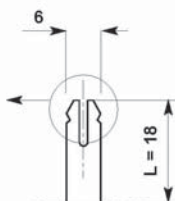

Spindle type 11
Optional

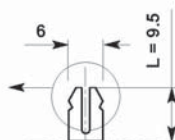

Spindle type 14
Optional

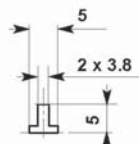

Spindle type 6
Optional



Carbon Slider Potentiometers

58 mm travel

Types
 CIPGST 2.58M
 PGST 2.58M
 CIPGST 2.58S
 PGST 2.58S

Mechanical data

Travel: 58 mm
 Operating force: 0.7 ± 2 N
 Permissible force at end stop: 50 N max
 Permissible lateral force on spindle, perpendicular to the direction of movement: 20 N max
 Permissible axial force on spindle, push and pull: 50 N (5 sec max)
 Permissible torque on spindle: 30 Ncm max
 Tap: Z2 at 50% of travel
 Weight: ~12 g

Optional features

- Central click
- Additional fixing tag, for CIPGST.2.58M type only

Electrical data

Rated dissipation @ 40°C: 0,4 W linear law
 0,2 W non-linear law
 Limiting element voltage: 500 VDC
 Insulation voltage: 500 VAC
 Rated resistance: E3 Series; optional E6 Series
 • linear law: 220R to 4M7
 • non-linear law: 470R to 2M2
 Tolerance on rated resistance:
 • 220R to 1M0: $\pm 20\%$
 • over 1M0: $\pm 30\%$
 Resistance law: A, B, C, F, S, T, X
 • with tap: A2, B2, C2, S2

Stereo types

Matching: class II
 • optional: class I

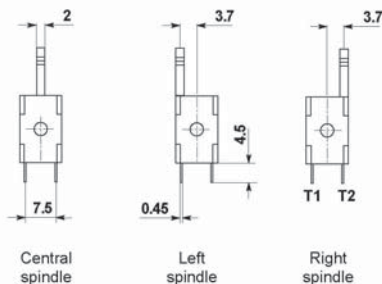
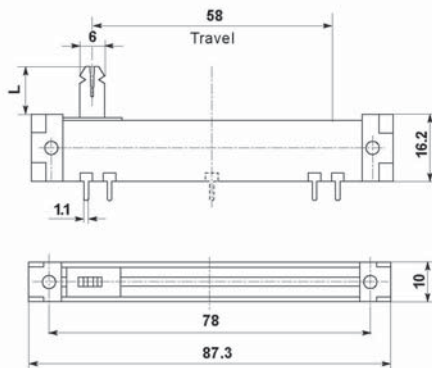

View from the beginning of travel side

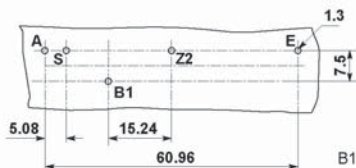

B1 = additional fixing tag

CIPGST 2.58M

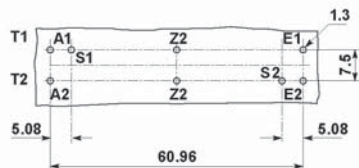

CIPGST 2.58S



Looking the potentiometer with terminations down, from the side with the marking, terminal A1 is situated on the left of opposite side.



Carbon Slider Potentiometers

58 mm travel

Types
CIPGST 2.58M
PGST 2.58M
CIPGST 2.58S
PGST 2.58S

Single types

CIPGST 2.58M	P.c. terminations
PGST 2.58M	Solder tag terminations

Stereo types

CIPGST 2.58S	P.c. terminations
PGST 2.58S	Solder tag terminations

Standard types

P.c. terminations: CIPGST 2.58 0100M
Solder tag terminations: PGST 2.58 0100M

Standard types

P.c. terminations: CIPGST 2.58 0100S
Solder tag terminations: PGST 2.58 0100S

Fixing nut variations

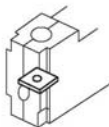

Pos. 1

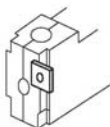

Pos. 2

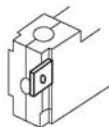

Pos. 3

M3 screws mounting from: top or bottom (Pos. 1), small vertical sides (Pos. 2), front or back (Pos. 3)

Spindle variations

Plastic

Thickness 2 mm

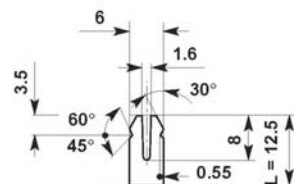

Spindle type 7
Standard

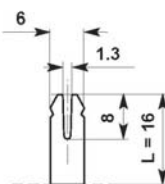

Spindle type 8
Optional

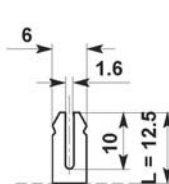

Spindle type 9
Optional

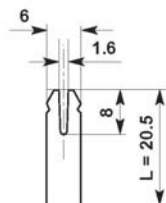

Spindle type 10
Optional

Ordering numbers

(CI) PGST 2.58 X X 0 X M
(CI) PGST 2.58 X X 0 0 S

- 0 - Central spindle type 7
- 1 - Left spindle type 7
- 2 - Right spindle type 7
- 3 - Central spindle type 8
- 4 - Left spindle type 8
- 5 - Right spindle type 8
- 6 - Central spindle type 9
- 7 - Left spindle type 10
- 8 - Right spindle type 10

- Single types only
- 0 - Without additional fixing tag
- 2 - With additional fixing tag

- 0 - Without nuts
- 1 - Nuts pos. 1
- 2 - Nuts pos. 2
- 3 - Nuts pos. 3



Carbon Slider Potentiometers

58 mm travel

Type
PGST 2.58H

Mechanical data

Travel:	58 mm
Operating force:	0.8 + 2.5 N
Permissible force at end stop:	50 N max
Permissible lateral force on spindle, perpendicular to the direction of movement:	20 N max
Permissible axial force on spindle, push and pull:	50 N (5 sec max)
Permissible torque on spindle:	30 Ncm max
Tap:	Z2 at 50% of travel
Weight:	~12 g

Optional feature

- Central click

Electrical data

Rated dissipation @ 40°C:	0,4 W linear law 0,2 W non-linear law
Limiting element voltage:	500 VDC
Insulation resistance:	≥ 5 G Ω
Insulation voltage:	500 VAC
Rated resistance: E3 Series; optional E6 Series	
• linear law:	220R to 4M7
• non-linear law:	470R to 2M2
Tolerance on rated resistance:	
• 220R to 1M0	± 20%
• over 1M0	± 30%
Resistance law:	A, B, C, F, S, T, X
• with tap:	A2, B2, C2, S2



PGST 2.58H

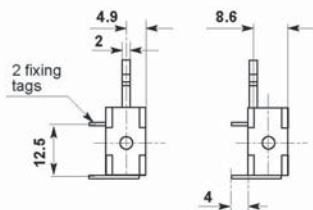
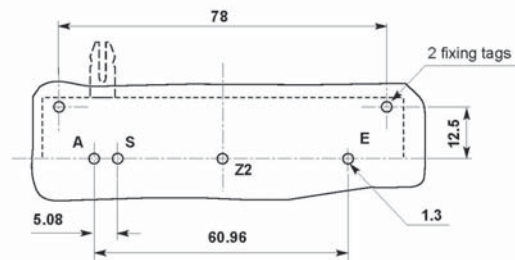
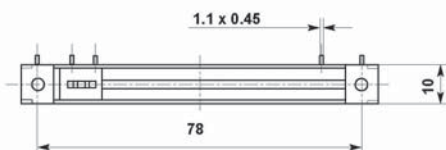
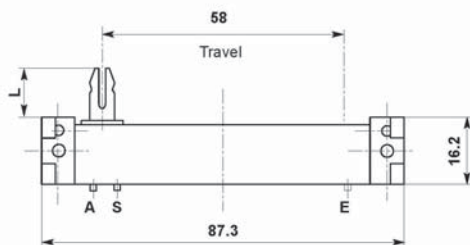

Central spindle
Left spindle
View from the beginning of travel side

Standard type: PGST 2.58H00

viewed on
component side



Ordering numbers

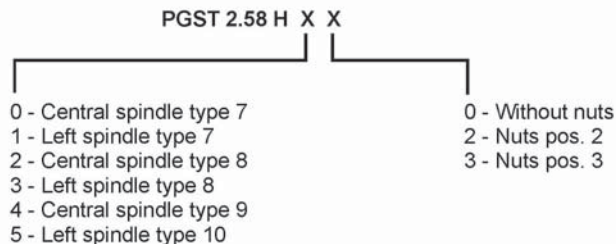

Fixing nut variations

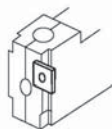

Pos. 2

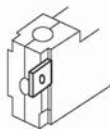

Pos. 3

M3 screws mounting from: small vertical sides (Pos. 2), front or back (Pos. 3)

Spindle variations

Plastic

Thickness 2 mm

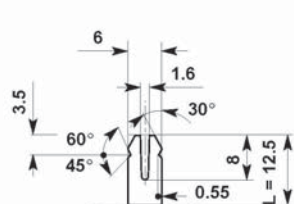

Spindle type 7
Standard

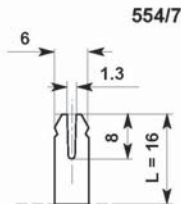

Spindle type 8
Optional

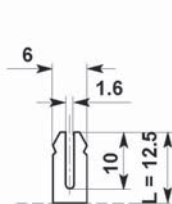

Spindle type 9
Optional

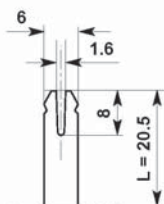

Spindle type 10
Optional



How to order

Désignation pour passer une commande

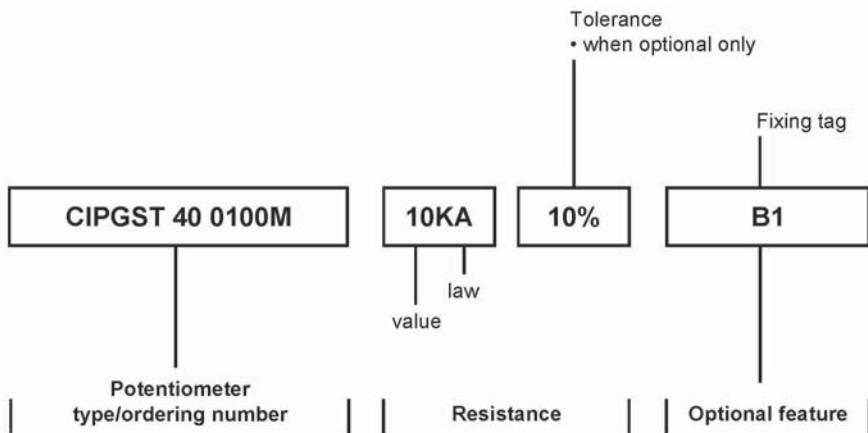

• Resistance laws: see p. 29 to 34.

Available resistance values, resistance laws, optional tolerance and optional features are specified on the pages describing each potentiometers type.



With slot for Control Device

Avec fente pour dispositif de commande

With Control Spindle

Types avec axe

With Control Spindle and Click-stops

Types avec axe et cran de position

How to order

Désignation pour passer une commande



Low cost displacing sensors for use in applications where a precise attenuation is needed along the complete specified rotation. They cannot be used as usual potentiometer.

Mechanical data

Rotation angle:	235° -0 +15°
Operating torque:	< 2 Ncm
Permissible torque et end stop:	<10 Ncm
Life test:	50,000 cycles
Weight:	~ 1,5 g

Electrical data

Rated dissipation @ 40°C:	0,2W
Limiting element voltage:	350 VDC
Rated resistance:	1K0 to 220K - E3 series
Climatic category:	-25°C +85°C
Resistance law:	AC, AD, see p. 138

Tolerance on rated resistance:

- Resistance law AC: ± 40%
- Optional: ± 20%
- Resistance law AD : ± 20%

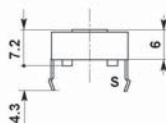

Slot is shown with the moving contact on centre line. (middle of travel)

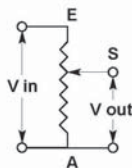
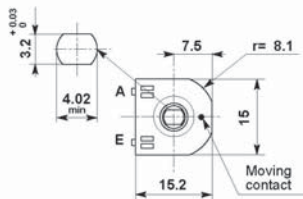

Use in attenuation only

viewed on component side

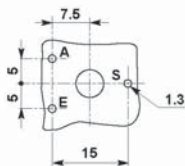

C15P
Horizontal mounting



Law type AD

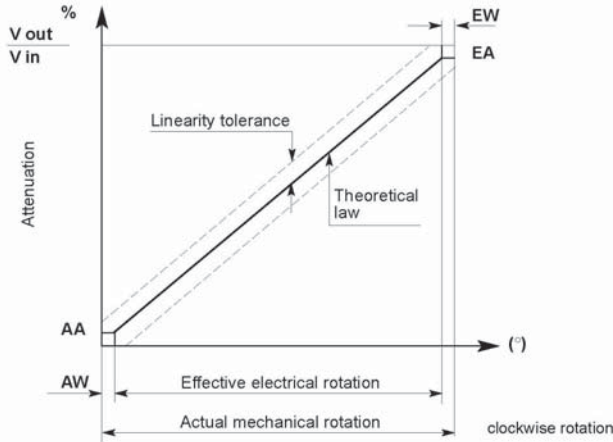

Linearity tolerance of attenuation:
 • standard: $\leq 5\%$
 • optional: $\leq 3\%$

AW = EW $\leq 10^\circ$
 AA $\leq 5\%$
 EA $\geq 95\%$

Within the specified tolerance limits, a single sensor assures the same attenuation value when the moving contact is repeatedly set in the same angle position.

Law type AC

Absolute linearity

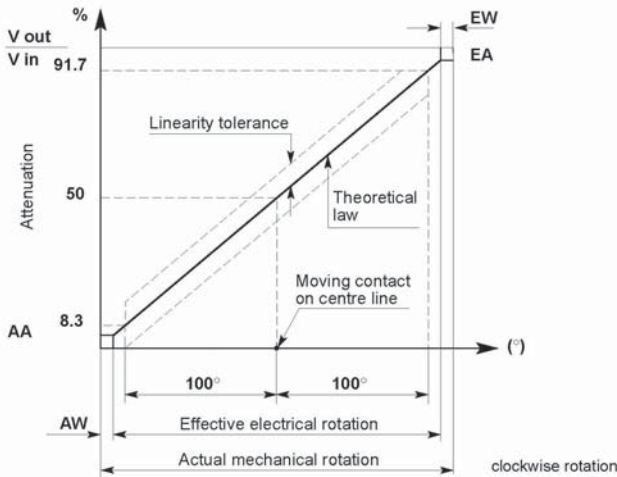

Linearity tolerance of attenuation:
 • standard: $\leq 5\%$
 • optional: $\leq 3\%$

AW = EW $\leq 10^\circ$
 AA $\leq 5\%$
 EA $\geq 95\%$

Within the specified tolerance limits, **every single sensor has the same attenuation value of all other sensors**, when the moving contact is in the same angle position. Moreover, the same attenuation value is assured when the moving contact is repeatedly set in the same angle position.

NEW



Rotary Position Sensors

Control Spindle

Type
EP165
P165S

Low cost displacing sensors for use in applications where a precise attenuation is needed along the complete electrical travel. They cannot be used as usual potentiometer.

Mechanical Data

Rotation angle:	$270^\circ \pm 5^\circ$
Operating torque:	$0.4 \div 1.5$ Ncm
Permissible torque et end stop:	40 Ncm max
Permissible axial spindle load:	100 N (5 sec max)
Rotation life:	> 15,000 cycles
Weight: EP165 type	~ 2 g
P165S type	~ 5 g

Electrical Data

Rated dissipation at @ 40°C:	0,12W
Limiting element voltage:	350 VDC
Insulation resistance:	≥ 5 G Ω
Rated resistance:	1K Ω to 220K - E3 Series
Tolerance on rated resistance:	$\pm 40\%$
• optional:	$\pm 20\%$
Resistance law:	AC
	see p. 141

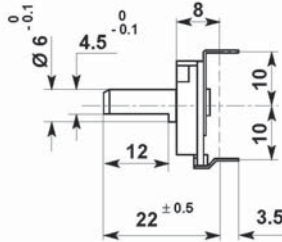

EP165

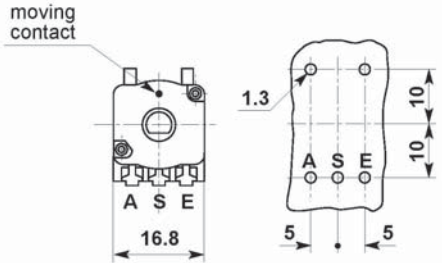

viewed on component side

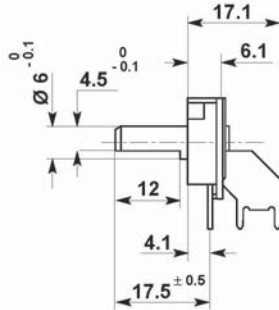

P165S

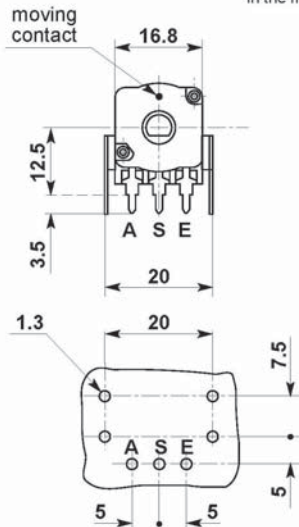

viewed on component side

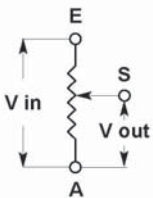

Use in attenuation only

Drawings show the spindle in the middle of travel

NEW



Low cost displacing sensors for use in applications where is needed both a precise attenuation along the complete electrical travel and to hold a position under mechanical vibrations. They cannot be used as usual potentiometer.

Mechanical data

Rotation angle:	270° ± 5°
Operating torque:	2 ± 6 Ncm
Permissible torque et end stop:	40 Ncm max
Permissible axial spindle load:	100 N (5 sec max)
Rotation life:	> 15,000 cycles
Weight: EP165R31 type	~ 2 g
P165SR31 type	~ 5 g

Electrical data

Rated dissipation at @ 40°C:	0,12W
Limiting element voltage:	350 VDC
Insulation resistance:	≥ 5 GΩ
Rated resistance:	1K0 to 220K - E3 Series
Tolerance on rated resistance:	± 40%
• optional:	± 20%
Resistance law:	AC

see p. 141

**31 click-stops
over 270°**

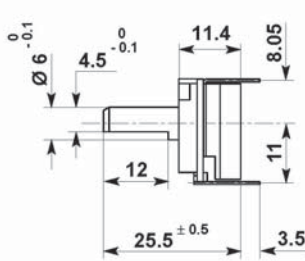

EP165R31

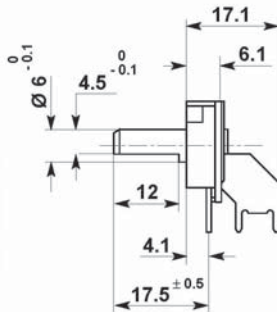
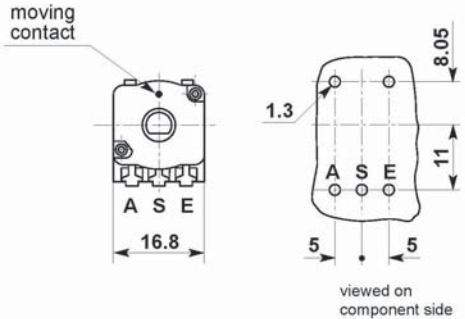

P165SR31

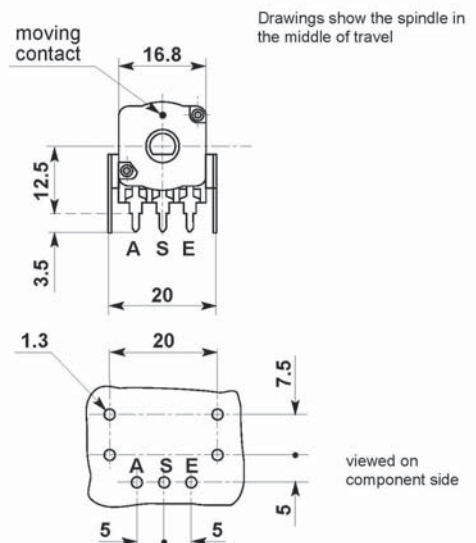

Drawings show the spindle in the middle of travel

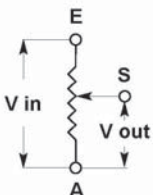

Use in attenuation only



Law type AC

Absolute linearity

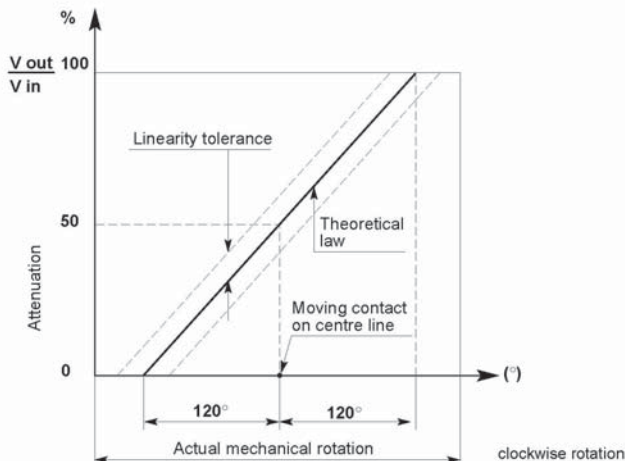

Linearity tolerance of attenuation:

- standard: $\leq 5\%$
- optional: $\leq 3\%$

$$R_a \leq 2 \cdot 10^{-3} R_N - \min 2 \Omega$$

$$R_e \leq 2 \cdot 10^{-3} R_N - \min 2 \Omega$$

Within the specified tolerance limits, **every single sensor has the same attenuation value of all other sensors**, when the moving contact is in the same angle position. Moreover, the same attenuation value is assured when the moving contact is repeatedly set in the same angle position.



How to order

Désignation pour passer une commande

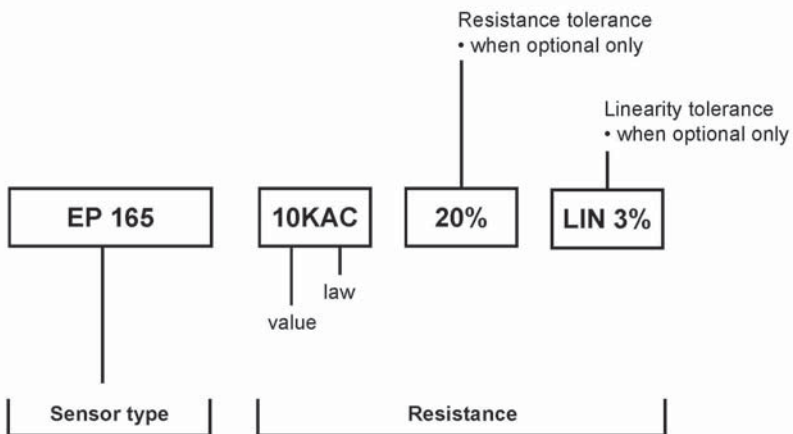

• Resistance laws: see p. 138 - 141.

Available resistance values, resistance laws, optional tolerances, are specified on the pages describing each sensor type.



Single Keys

Contacteur sensi-touche

Push Button Switches and
Keyboards

*Commutateurs à poussoir et
claviers*



Single Keys

1 - Pole

Types
ST 1034
ST 1034D
ST 1034E

Mechanical Data

Travel:	0.6 ± 0.1 mm
Operating force:	0.8 ± 2.5 N
Permissible force at end stop:	50 N (1 min max)
Contact bouncing:	≤ 0.5 ms
Life:	$\geq 1,000,000$ cycles
Weight:	~ 1 g

Electrical Data

Breaking capacity:	20 mA - 30 VDC
Contact resistance:	≤ 25 m Ω
Insulation resistance:	≥ 1 G Ω
Rated temperature range:	-20°C to +70°C

Features:

- Short travel
- Momentary switch with "click-effect"
- Self-cleaning contact
- Suitable for keyboards arrangement.

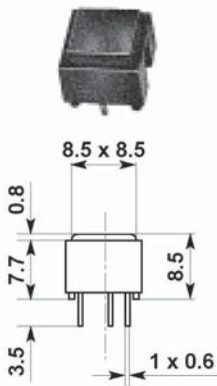

ST 1034
1-pole

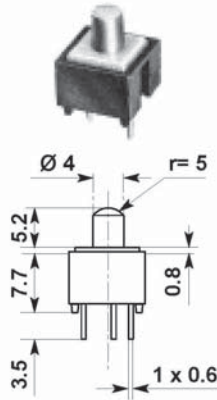

ST 1034D
1-pole

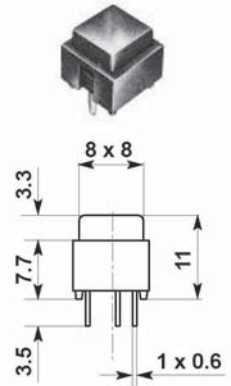

ST 1034E
1-pole

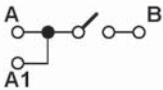

Button colour
Standard: black
Optional: light grey, red, yellow, blue, green
Case colour: black

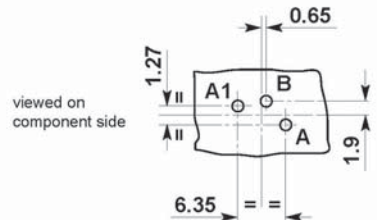



Single Keys

1 - Pole

Type
ST 1034F

Mechanical Data

Travel:	0.6 ± 0.1 mm
Operating force:	$0.8 + 2.5$ N
Permissible force at end stop:	50 N (1 min max)
Contact bouncing:	≤ 0.5 ms
Life:	$\geq 1,000,000$ cycles
Weight:	~ 1.10 g

Electrical Data

Breaking capacity:	20 mA - 30 VDC
Contact resistance:	≤ 25 m Ω
Insulation resistance:	≥ 1 G Ω
Rated temperature range:	-20°C to $+70^{\circ}\text{C}$

Features:

- Short travel
- Momentary switch with "click-effect"
- Self-cleaning contact
- Suitable for keyboards arrangement

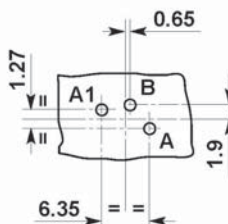
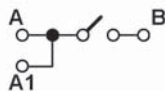
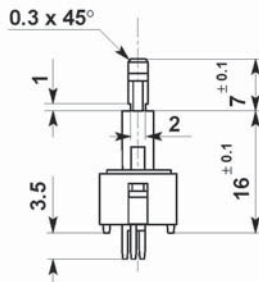
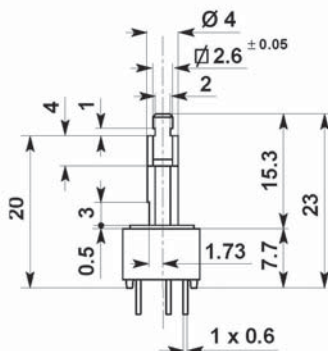

viewed on component side

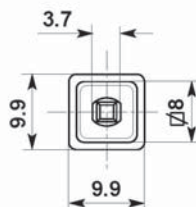

ST 1034F
1-pole

Button colour

Standard: black

Optional: light grey, red, yellow, blue, green

Case colour: black



Single Keys

1-Pole & 2-Pole

Type
ST 1044
ST 1042

Mechanical data

Travel:	0.6 ± 0.1 mm
Operating force:	$0.8 + 2.5$ N
Permissible force at end stop:	50 N (1 min max)
Contact bouncing:	≤ 0.5 ms
Life:	$\geq 1,000,000$ cycles
Weight:	~ 1.35 g

Electrical data

Breaking capacity:	20 mA - 30 VDC
Contact resistance:	≤ 25 m Ω
Insulation resistance:	≥ 1 G Ω
Rated temperature range:	-20°C to $+70^{\circ}\text{C}$

Features

- Short travel
- Momentary switch with "click-effect"
- Self-cleaning contact
- Suitable for keyboards arrangement

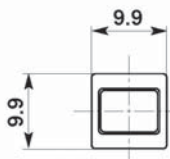
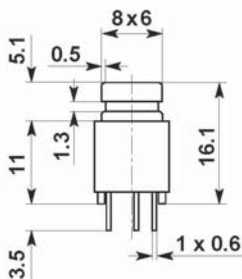

ST 1044
1-pole

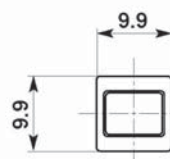
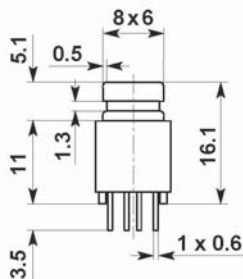

ST 1042
2-pole

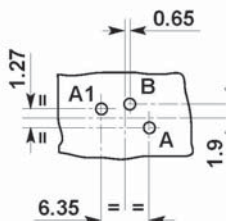
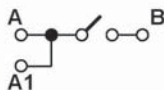

viewed on
component side

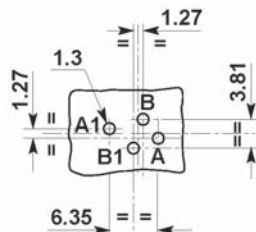

Button colour

Standard: black
Optional: light grey, red, yellow, blue, green

Case colour: black





Mechanical Data

CT32

Terminations pitch:	3.2 mm
Latching travel:	2.6 mm
Total travel:	3.8 mm

CT40

Terminations pitch:	4 mm
Latching travel:	2.6 mm
Total travel:	3.8 mm

Operating force CT32D and CT40D

- 2 changeovers and release blocks:	≤ 2,4 N
- 4 changeovers block:	≤ 3 N
- 6 changeovers block:	≤ 4 N

Operating force CT32F and CT40F

- 2 changeovers and release blocks:	≤ 3 N
- 4 changeovers block:	≤ 4 N
- 6 changeovers block:	≤ 6 N

Permissible force applied in operation direction:	100 N (10 sec max)
Life single block:	operations ≥ 50,000
Life keyboard:	operations ≥ 100,000

Electrical Data

Dielectric strength:	1.000 VAC
Contact resistance:	≤ 15 mΩ
Insulation resistance:	> 5 GΩ at 100 VDC
Inter-contacts capacity:	≤ 1.5 pF at 1 MHz
Capacity between one contact and all other connected contacts:	≤ 3 pF at 1 MHz

Breaking capacity

CT32D and CT40D	0.35 A - 12 VDC
CT32F and CT40F	
• standard:	0.35 A - 12 VDC
• optional:	1 A - 12 VDC

Load life:	> 15,000 operations
Rated temperature range:	-20°C to +70°C

According to NCF 93410 and IEC 341-1.

Mechanical functions

Independent (push-push) block: inserted by pressing, it returns to the rest position when pressed again.

Interlocked (connected) block: inserted by pressing, it makes the previously inserted blocks return to the rest position.

Free (momentary action) block: inserted while pressing, it returns to the rest position when released.

Zero (release) block: without changeovers circuit; when pressed it makes all other inserted blocks return to the rest position; the button remains in the inserted position when pressed.

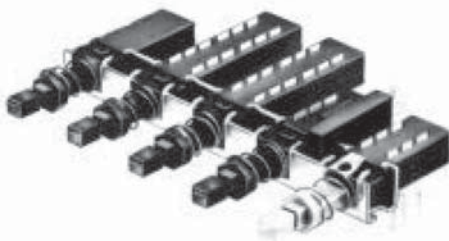
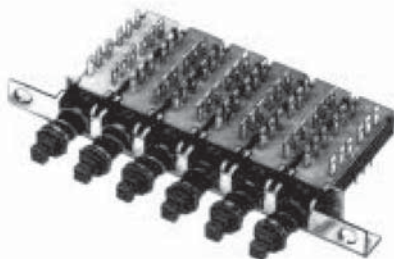

Series CT32 is described from p. 151 to 153.
Series CT40 is described from p. 154 to 156.

Single Blocks

Fixing on P.c. board by terminations

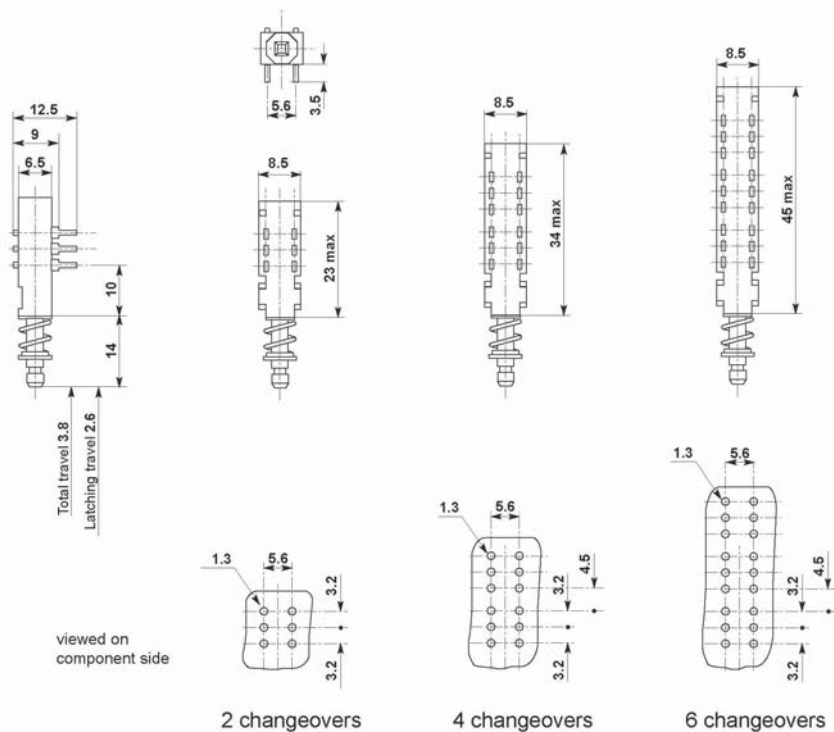

Push-push function

Type	Changeovers
CT32D.2N.FT	2
CT32D.4N.FT	4
CT32D.6N.FT	6

Momentary function

Type	Changeovers
CT32D.2F.FT	2
CT32D.4F.FT	4
CT32D.6F.FT	6

Spindle and termination details: see p. 157
Buttons: see p. 158.



Single Blocks

Fixing by bracket

Standard: H = 6.4 h = 4.1 mm
Optional: H = 7 h = 3.5 mm
H = 12.5 h = 3.5 mm

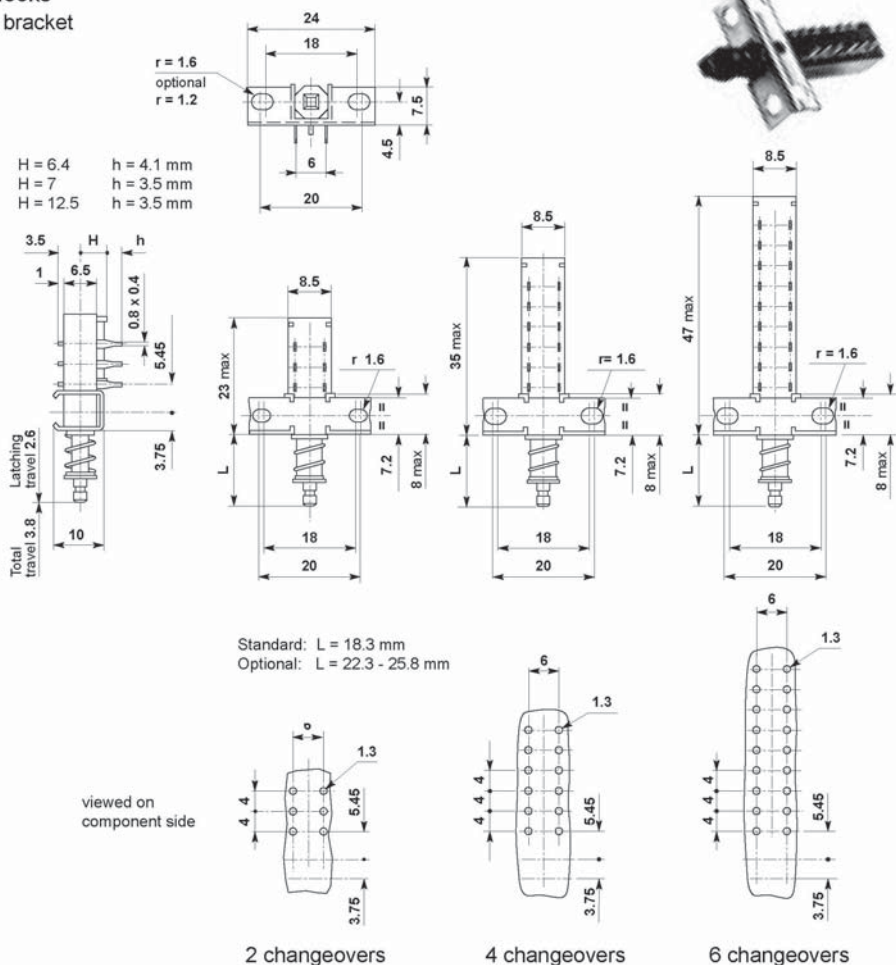

Standard: L = 18.3 mm
Optional: L = 22.3 - 25.8 mm

viewed on component side

Push-push function

Type	Changeovers
CT40D.2N.F10	2
CT40D.4N.F10	4
CT40D.6N.F10	6

Momentary function

Type	Changeovers
CT40D.2F.F10	2
CT40D.4F.F10	4
CT40D.6F.F10	6

Spindle and termination details: see p. 157. Buttons: see p. 158.



Keyboards
Assembly example

Standard: H = 6.4 h = 4.1 mm
Optional: H = 7 h = 3.5 mm
 H = 12.5 h = 3.5 mm

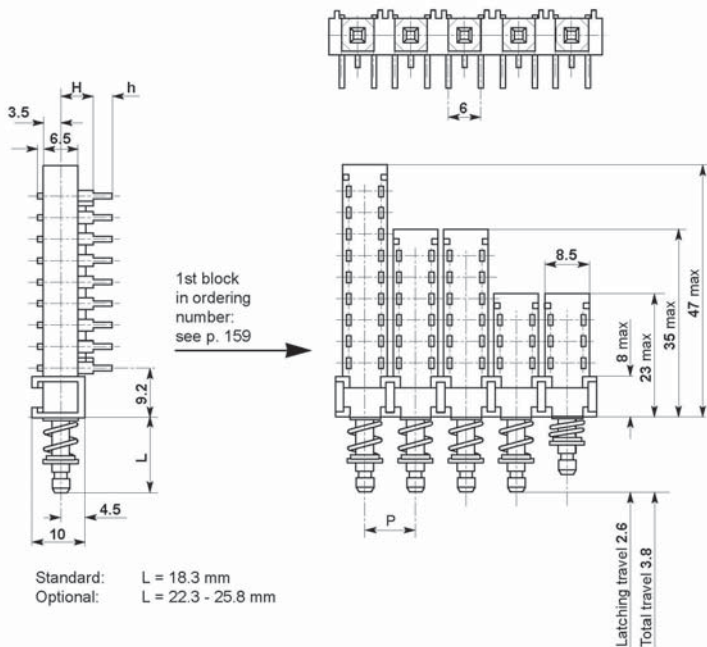

viewed on component side

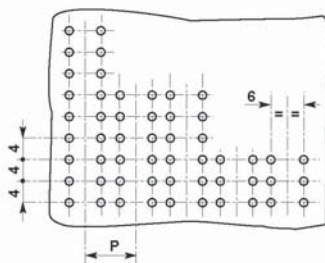

Available pitches between blocks: P = 10 - 12.5 - 15 - 20 mm

- A keyboard may have different pitches between blocks: 10 - 15 - 20 mm
- Keyboards with pitch 10 mm: the 1st block must be interlocked.

Bracket. Drawing refers to mounting bracket FS style; see other available mounting bracket styles at p. 158.

Terminations. Drawing shows to terminations CI type; see other available terminations types at p. 157. A keyboard may have different termination types.

Spindle details: see p. 157.

Buttons: see p. 158.



CT32 - terminations pitch 3.2 mm

Spindle

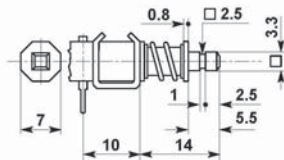

Terminations

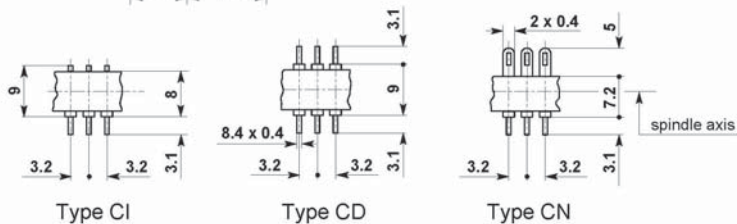

CT40 - terminations pitch 4 mm

Spindles

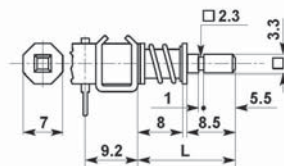

Type 1 standard

Standard L = 18.3 mm
Optional: L = 22.3 - 25.8 mm

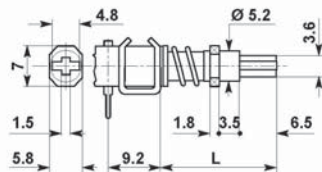

Type 2 optional

Standard: L = 19.8
Optional: L = 23.8 - 27.3

Terminations

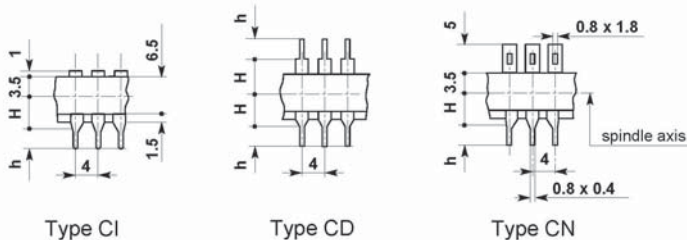

Type CI

Type CD

Type CN

Standard: H = 6.4 h = 4.1 mm Optional: H = 7 h = 3.5 mm
for type CI only
H = 12.5 H = 3.5 mm



Mounting Brackets

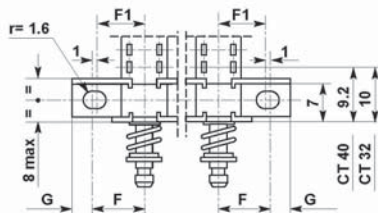
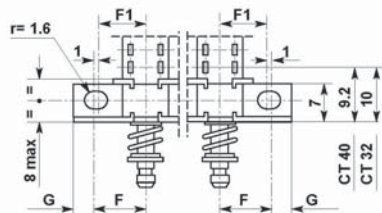
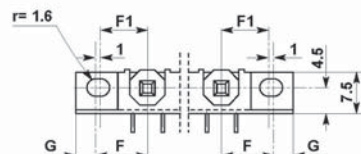
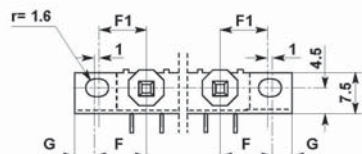

F1 style Max length = 213.5 mm

F2 style Max length = 213.5 mm

Pitch between blocks = mm	Bracket type	F	F1	G
10 - 20	F10	10	9	2
12.5	F10	10	9	3
15	F12	15	14	2

Pitch between blocks = mm	Bracket type	F	F1	G
10 - 20	F20	10	9	2
12.5	F20	10	9	3
15	F22	15	14	2

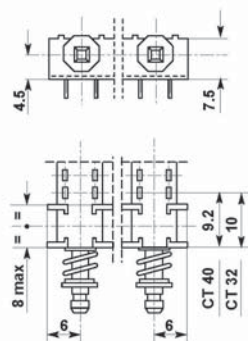

FS style
Max length = 212 mm

Buttons
plastic

Standard: black

Optional: light grey, red, yellow, blue, green.

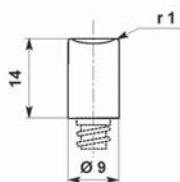

Type C1

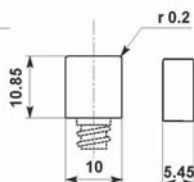

Type C2

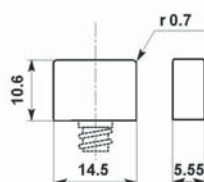

Type C3

Ordering number for keyboards
Codes pour commandes des claviers

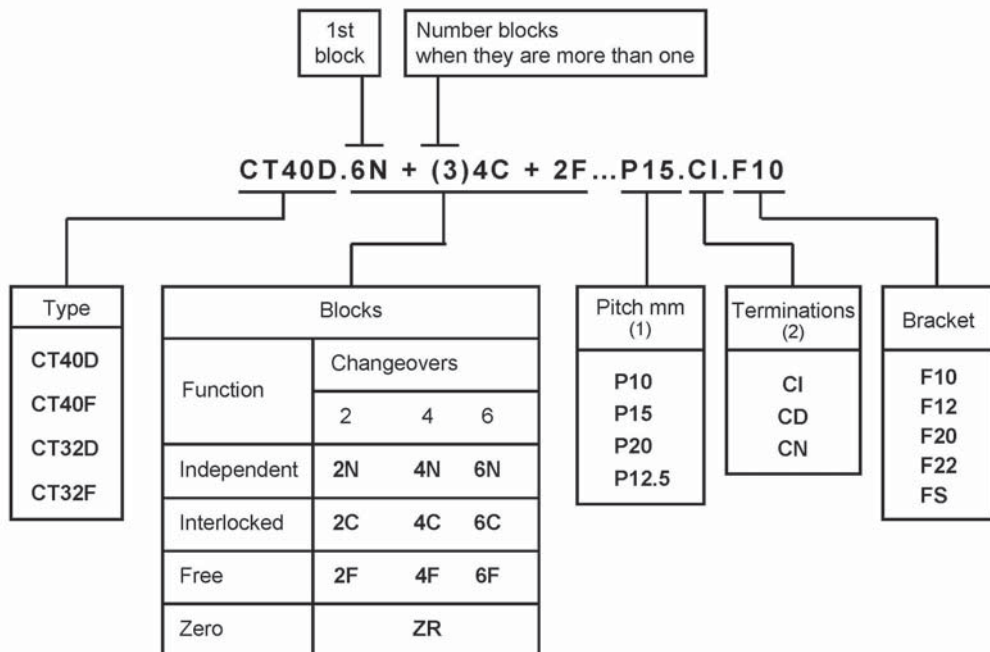

- (1) For keyboards with combined pitches, the lengths of pitches must be indicated after each block designation.

Pour les claviers avec pas combinés, ceux-ci doivent être indiqués à la suite de la désignation de chaque cellule.

Example: CT 40D.6N.P15 + (3)4C.P10 + 2F.P20...CI.F10

- (2) For keyboards with different terminations, the type of the terminations must be indicated after each block designation.

Pour les claviers avec les cosses différentes, les types des cosses doivent être indiqués à la suite de la désignation de chaque cellule.

Example: CT 40D.6N.CD + (3)4C.CI + 2F.CN...P15.F10



Technology and applications

Technologie et applications

Features and options

Configurations et options

Standard types

Types standards



Technology and applications

Membrane keyboards are the command units for electronic appliances; they simplify the input of information and data.

Membrane keyboards are a typical custom-product. In the following, basic information are given in order to correctly design a suitable configuration.

Membrane keyboards are constructed with polyester (100 to 250 μ mm), or polycarbonate foils (100 to 400 μ mm). The circuit and contacts consist of electrically conductive layers, usually silver and carbon loaded inks, and fixed by a screen printing process.

The decor foils are printed with the required design in various colours, normally on the rear, thus excluding the possibility of abrasion damage. They are then glued with the conductive foils into a compact unit.

Membrane switching systems offer to electronic engineer and designer the opportunity to employ a flat, light weight and compact device, in a wide range of applications in consumer electronics, photography, medicine, household appliances and other industrial fields.

Grid system and number of switching contacts are designed according to customer's requirement.

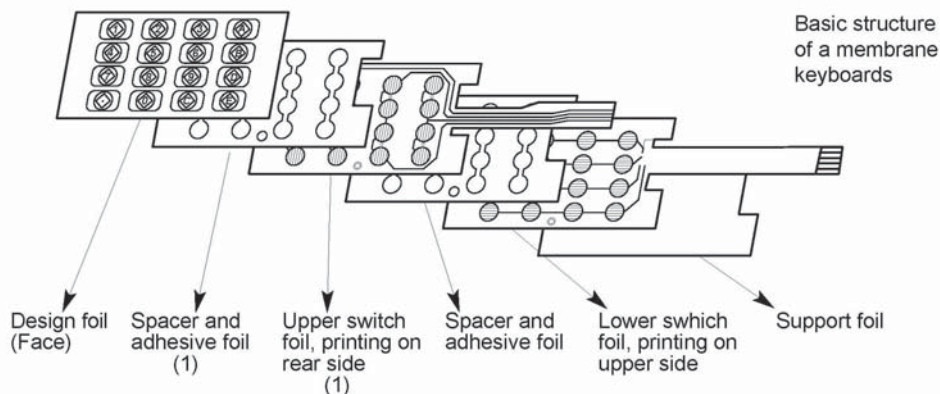

(1) These foils can be eliminated: the upper switch circuit is printed on the rear to designe foil.



Features and options of switching devices

Without tactile effect

Flat surface

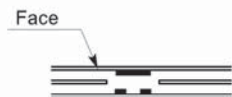

Operating force

< 5 N

Life cycles

≥ 4,000,000

Embossed edge key areas
(finger guide)

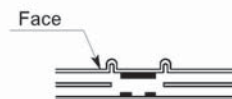

< 5 N

≥ 4,000,000

With tactile effect

Embossed key areas



< 7 N

≥ 1,000,000

Metal dome switches



< 7 N

≥ 1,000,000

Metal dome switches
and embossed edge key areas
combined.

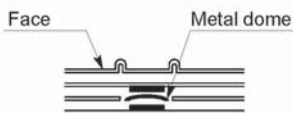

< 7 N

≥ 1,000,000



Features and options

Materials

- Stabilized polyesters
- Polycarbonates

Connections

- Female standard connector
- Standard pins for soldering
- Open tail to be fitted in the proper connector

Graphic features

- Various surface UV coating (satin, mat, textured, etc.)
- Coating and filtered color windows

Miscellaneous

- Insertion of leds
- Reinforced dielectric rigidity.
- Various kinds of cuts through or intra-foils
- Earth and RFI shielding

Specifications

- | | | | |
|--------------------------|--------------|------------------------|----------------|
| • Contact rating: | 40 mA-48 VDC | • Temperature range: | -25°C to +85°C |
| • Insulation resistance: | >100 MΩ | • Storage temperature: | -40°C to +85°C |
| • Contact bounce: | < 1.5 ms | | |

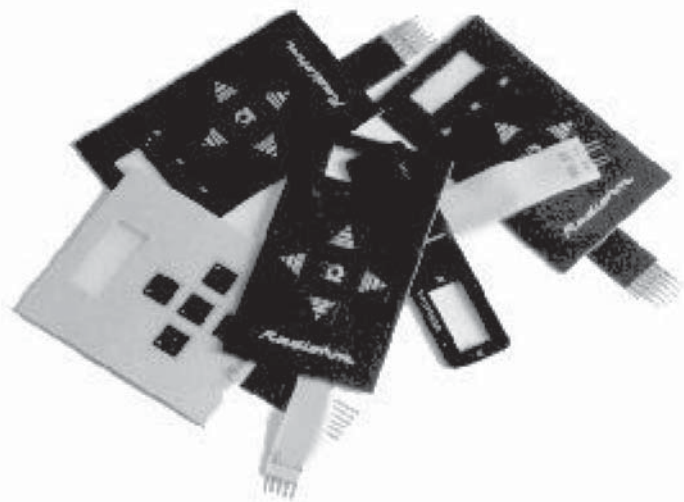

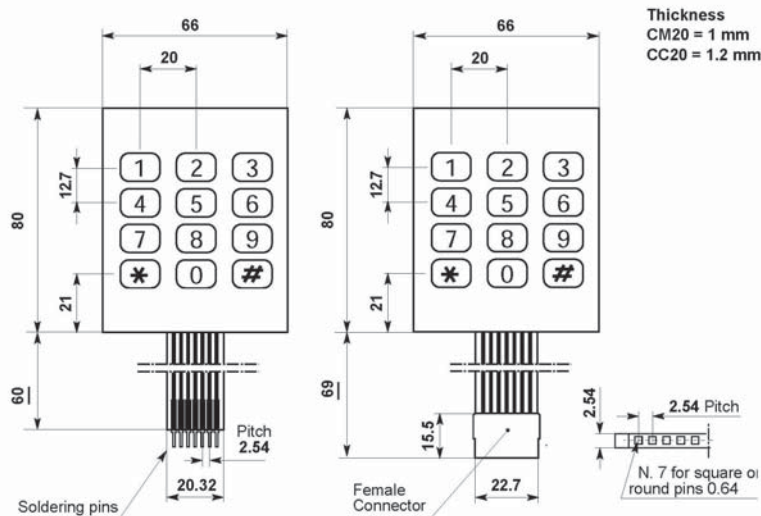

CM20 12 00
Flat surface

CM20 12 10
Flat surface

CC20 12 00
Metal dome switches

CC20 12 10
Metal dome switches

Colours: white, black writing.

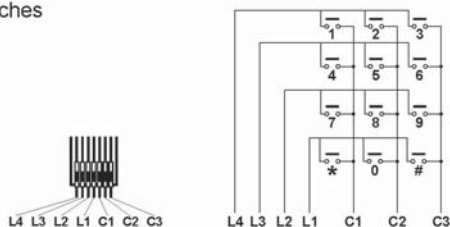

Standard types

Code	Tactile effect	Life cycles	Operating force	Total resistance	Connection
CM20 12 00	without	$\geq 4,000,000$	$< 5 \text{ N}$	$< 15 \Omega$	Pins
CC20 12 00	with	$\geq 1,000,000$	$< 7 \text{ N}$	$< 12 \Omega$	
CM20 12 10	without	$\geq 4,000,000$	$< 5 \text{ N}$	$< 15 \Omega$	Connector
CC20 12 10	with	$\geq 1,000,000$	$< 7 \text{ N}$	$< 12 \Omega$	

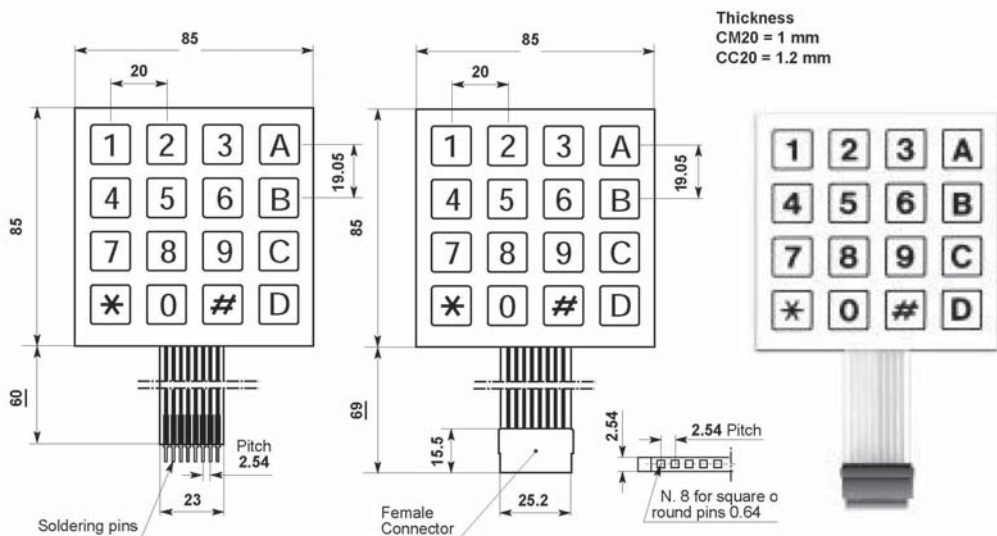

CM20 16 00
Flat surface

CM20 16 10
Flat surface

CC20 16 00
Metal dome switches

CC20 16 10
Metal dome switches

Colours: white, black writing.

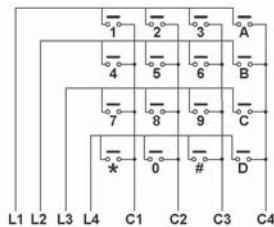

Standard types

Code	Tactile effect	Life cycles	Operating force	Total resistance	Connection
CM20 16 00	without	$\geq 4,000,000$	$< 5 \text{ N}$	$< 19 \Omega$	Pins
CC20 16 00	with	$\geq 1,000,000$	$< 7 \text{ N}$	$< 16 \Omega$	
CM20 16 10	without	$\geq 4,000,000$	$< 5 \text{ N}$	$< 19 \Omega$	Connector
CC20 16 10	with	$\geq 1,000,000$	$< 7 \text{ N}$	$< 16 \Omega$	